



GUIDE TO THE CHICAGO LANDSCAPE ORDINANCE

*Regulations and guidelines relating to Title 10, Chapter 32 and
Title 17, Chapter 194A of the Chicago Municipal Code*



City of Chicago
Richard M. Daley, Mayor



OFFICE OF THE MAYOR
CITY OF CHICAGO

RICHARD M. DALRY
MAYOR

August 2000

Dear Fellow Chicagoans:

Nearly ten years ago, we introduced the *Guide to the Chicago Landscape Ordinance*. In the decade since, this guide has become a valuable resource in amplifying and illustrating the requirements of the Landscape Ordinance. Through consistent application and enforcement of the ordinance, we have moved close to our goal of greener neighborhoods, tree-lined streets and boulevards, more attractive commercial streets, and enhanced property values.

Now, as we embark upon a new millennium, this administration and the City Council have again taken the lead in beautifying our city by passing a revised Landscape Ordinance. I invite you to study this *Guide to the Chicago Landscape Ordinance* to understand these changes and the new ways in which we can all improve the character of our city.

I commend the individuals who have contributed their knowledge and support to this effort. I urge the citizens of Chicago to join in wholehearted support of our new Landscape Ordinance. I look forward to all of us sharing in the benefits of an increasingly beautiful city.

Sincerely,

A handwritten signature in cursive script that reads "Richard M. Daley".

Mayor



Introduction	1
Applicability	3
Permit review	5
Summary of landscape requirements	7
Chapter 1: Parkway planting	11
Chapter 2: Parking lot and vehicular use area screening	17
Chapter 3: Parking lot and vehicular use area internal planting	21
Chapter 4: Parking structures and garages	25
Chapter 5: Enhancements	27
Chapter 6: Growing medium	29
Chapter 7: Maintenance and warranty	33
Appendix A: Definitions	35
Appendix B: Required information	37
Appendix C: Plant types and standards	39
Appendix D: Planting details	51
Appendix E: Structural soil	55
Appendix F: Landscape maintenance schedule	57
Appendix G: Sworn statements	61
Appendix H: Public notice of required landscaping	63
Appendix I: Public notice of maintenance schedule and agreement	65

The goal of Chicago's landscape ordinance has been to help us live up to the description of Chicago captured in our City seal: "Urbs in Horto," or City in a Garden. Our objective is an attractive city of tree-lined streets and boulevards, greener neighborhoods, and enhanced property values. Chicago has had a strong landscape ordinance in effect since 1991, and many of those objectives have already been achieved. Hundreds of projects have planted thousands of trees and shrubs in parkways and around or within parking lots since that time.

The people of Chicago (residents, business owners, and visitors alike) benefit from a more beautiful city filled with trees, shrubs, and flowers. We all benefit when the high temperatures of the "urban heat island" are lowered by the extensive use of spreading canopy trees over hot, asphalt paved streets parking lots. Birds and other wildlife benefit from the nesting and resting habitat, refuge, and food sources provided by landscaping in what could otherwise be a sterile urban environment.

The City of Chicago has led by example in the area of urban landscaping, and has not asked others to do what it is not willing to do itself. Streetscape projects have resulted in greening and beautification throughout the city. Schools, libraries, police and fire stations, and other public buildings are, almost without exception, designed and built with consideration for landscaping and beautification. It is desired that all public building projects plant trees measuring a minimum of 4" caliper at time of planting.

The landscape ordinance adopted in 1991 required projects above a minimum size (not including single family homes, two-flats, and three-flats) to install and maintain landscaping as part of their construction, repair, or rehabilitation. Landscaping was required in three basic categories:

- Parkway planting
- Parking lot and vehicular use area screening
- Parking lot and vehicular use area internal planting

It is the intent of this revised landscape ordinance to make Chicago healthier and more beautiful. This may be done by initiating landscaping requirements in areas which were previously overlooked, or by increasing landscaping requirements where the existing requirements have turned out to be inadequate, or by defining requirements more carefully, so that landscaping is not avoided through use of unintentional "loopholes." In addition to strengthening existing requirements, landscaping and other related enhancements will be required in the following additional categories:

- Parking structures and garages
- Enhancements (planters, street furnishings, etc.)
- Growing medium and planter design

Not all of the landscape requirements are being changed. Some of the basic features, including projects that are exempt from landscaping requirements, remain the same. Parkway trees, for example, will still be required at the rate of one (1) tree per twenty-five linear feet (LF) of street frontage; the size of the trees, however, will be increased. The "Summary" section provides an overview of the new landscaping requirements, and the balance of this document provides a detailed explanation and illustration of all of the new landscaping requirements.

What types of projects are exempt from landscaping requirements?

- Construction, repair, or rehabilitation of any one, two, or three family dwelling
- Restoration of any building or portion thereof damaged by fire, explosion, flood, casualty, or other calamity
- Construction, repair, or rehabilitation of any accessory (e.g., garage, fence, etc.) buildings or structures

In what other instances is landscaping not required?

- Parkway trees are not required where the parkway (the distance from the curb to the right-of-way) is less than nine (9) feet wide
- Screening is not required for parking lots or other vehicular use areas smaller than 1,200 square feet (SF)
- Internal planting is not required for parking lots or other vehicular use areas smaller than 3,000 SF

What types of projects are required to install and maintain landscaping?

Parkway planting is required for:

- Construction of any principal building (i.e., the main building or structure, as opposed to an accessory use or structure)
- Additions to buildings in excess of 1,500 SF of floor area
- Repair or rehabilitation of a building if the cost exceeds \$10,000 or 50 percent of the building's replacement cost, whichever is greater
- Construction of any parking lot or other vehicular use area greater than 1,200 SF
- Repair, rehabilitation, or expansion of any existing parking lot or other vehicular use area containing more than 1,200 SF of such repair, rehabilitation, or expansion would increase the number of existing parking spaces by more than 25 percent or 4 spaces
- Diagonal parking designed and constructed within the right-of-way

Landscape screening around parking lots and other vehicular use areas is required for:

- Construction of any vehicular use area of 1,200 SF or more which is visible from a public right-of-way
- Construction of any vehicular use area of 1,200 SF or more contiguous to a Residence District or existing institution (e.g., schools, hospitals, churches, etc.)
- Repair, rehabilitation, or expansion of any existing parking lot or other vehicular use area more than 1,200 SF if such repair, rehabilitation, or expansion would increase the number of existing parking spaces by more than 25 percent or 4 spaces, whichever is less.

Landscape planting within parking lots and other vehicular use areas is required for:

- Construction of vehicular use areas of 1,200 SF or more.

Is a special permit necessary for the installation of required landscaping?

- A permit is required from the Bureau of Forestry to remove, plant, trim, or take any action that will, in any way, affect the health of trees in the public right-of-way.
- A separate landscape permit is not required for other landscape materials. Landscaping permits are a part of the normal process of building and zoning permit applications. If you are required to apply for building or zoning permits, you may be required to submit landscaping plans. You should 1) determine whether the project is subject to the requirements of these Guidelines, 2) determine the exact requirements, 3) prepare a landscape plan, and 4) submit the plan to the Department of Zoning (Room 800, City Hall, 121 North LaSalle Street, Chicago, Illinois 60602) as a part of the building permit application.
- The Department of Zoning will review and approve or disapprove the landscape plan. If it is not approved, specific recommendations to bring the landscape plan into conformance with these Guidelines will be noted on the correction sheet.

What information must be submitted?

- See Appendix B for a checklist of required information. A copy of this checklist should be attached to the landscape plan and filled out by the applicant prior to submission.
- Landscape permit drawings must contain the sworn statement by the owner and registered landscape architect that the drawings have been prepared in accordance with the requirements of the Landscape Ordinance of the City of Chicago and of the *Guide to the Chicago Landscape Ordinance*.

What types of plant materials are acceptable?

- See Appendix C for a list of acceptable trees, shrubs, and other plants

Can the landscaping requirements be waived?

- The screening or landscape requirements may be waived or modified provided that the Zoning Administrator finds that 1) the strict application of the requirements would deprive the applicant of reasonable use of the land or would otherwise impose an unreasonable hardship, and 2) the conditions and circumstances upon which the waiver or modification is sought are not caused by the applicant. Furthermore, the Zoning Administrator may permit an architectural or urban design solution to the screening of parking areas provided the alternative meets the requirements of Subsection 11.7A-3 (10) of the Chicago Zoning Ordinance.

How long does it take to get a permit?

- A landscape plan will require no more time than is required for normal processing of building and zoning applications. In some cases, conditional approval of your zoning permits may be received pending the Bureau of Forestry's review of proposed parkway trees. The Bureau of Forestry will process parkway tree plans and permits within seven working days.

How will the landscaping requirements be enforced?

- Personnel from the Department of Zoning will inspect project sites to ensure that the required landscaping has been installed. A Certificate of Occupancy will not be issued until inspectors have visited the site and determined that the required landscaping has been installed. Surface parking lots and other vehicular use areas require a Certificate of Occupancy.
- If weather prevents the installation of required landscaping, the Zoning Administrator will require a performance bond to insure that the required landscaping will be installed within a reasonable time period (up to six months). Following the installation of the required landscaping and inspection by the city personnel, the performance bond will be released.
- If an applicant is planting more than twenty-five (25) parkway trees, the Bureau of Forestry requires that all tree tagging be done by a Bureau representative prior to digging. Applicants should ensure that the nurseryman supplying the trees and the landscape architect observing the planting are familiar with the Bureau's standards and specifications. In other situations, the Bureau's staff will inspect trees at the nursery if requested by the applicant. In such cases, the applicant must pay all Bureau expenses for inspection including the cost of travel, lodging (if necessary), and a ten percent administrative overhead fee.
- A permit must be obtained from the Bureau of Forestry prior to planting trees in the public right-of-way.

What is an acceptable performance bond?

- When a performance bond is required, the building owner shall post such bond with the Comptroller of the City of Chicago. A performance bond may include City securities or fixed income securities, at the Comptroller's discretion, to ensure the installation of the required landscaping.
- In the event of a failure in the required performance, the Zoning Administrator shall notify the building owner of such failure and shall stipulate the period of time in which the building owner has to correct the failure. If the failure is not corrected in the stipulated time, the Zoning Administrator may declare the building owner in default of the required performance, and the City may enforce the obligation by whatever means may be appropriate to the situation. This includes letting contracts for doing any required planting, installation, or maintenance, and paying all labor, material and other costs connected with such work from the bond or City securities the building owner is required to provide.
- The Department of Zoning shall write and let a contract for the installation

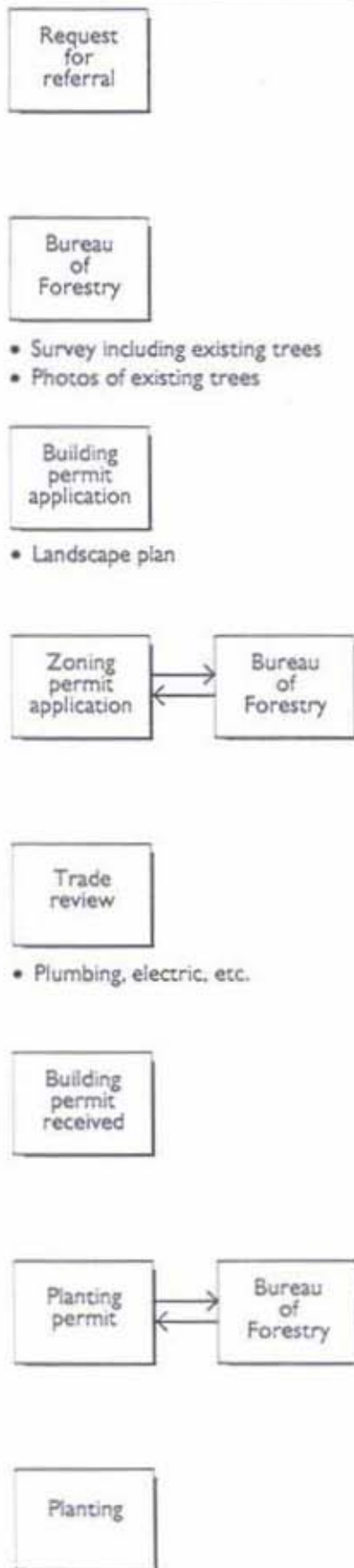

of required landscaping for projects in default. Once the contract is awarded, the bonding prices will be based upon the contract bid prices. Having a contractor readily available to install landscaping will encourage developers to complete the landscaping on their own. Also, this contract can be re-bid at appropriate intervals to keep bonding amounts competitive and current with market prices.

The value of the bond or City securities are as follows:

\$750.00 per required 4" or greater caliper tree in greater downtown area
\$500.00 per required 2.5" or greater caliper tree
\$50.00 per required shrub
\$5.00 per square foot of required landscaped area

Who is responsible for the maintenance of required landscaping?

- All required landscaping must be maintained by the property owner in good condition. Any damaged or dead trees, shrubs, or groundcover must be promptly replaced. Maintenance of landscaped areas includes, but is not limited to, weeding, mowing, trimming, pruning edging, cultivation, seeding, fertilization, watering, pest control, and anything else necessary to ensure healthy, vigorous plant growth and maintain the area in a slightly condition.
- The landscape ordinance requires property owners to maintain parkway trees for a minimum period of five years following their initial planting. After this five year period, the City's Bureau of Forestry will assume responsibility for the maintenance of parkway trees. Landscaping installed on private property must be maintained during all times that the property is in use.
- For more information, contact:

Zoning Desk
Department of Planning and Development
City Hall, Room 1000
121 North LaSalle Street
Chicago, Illinois 60602
(312) 744-9445

Highlights of the landscape ordinance are as follows; see following chapters for complete lists of requirements:

Parkway planting

- One (1) tree per twenty-five (25) linear feet (LF) of frontage on a public right-of-way
- Four (4) inch minimum caliper trees within the "greater downtown" (area bounded by North Avenue, Lake Michigan, Cermak Road, and Ashland Avenue)
- Two-and-one-half (2-1/2) inch minimum caliper trees outside the "greater downtown"
- All public building projects should, but are not required to, install four (4) inch minimum caliper trees, regardless of location relative to the "greater downtown"
- Continuous, open planters with continuous planting soil volumes are preferred
- Tree grates are required where trees are planted in sidewalk openings; use of grates made from recycled materials is encouraged
- Structural soil or root paths are required below sidewalks when tree grates are used
- Black lava rock mulch and 18 gauge galvanized hard wire mesh are required in tree pits below tree grates in the greater downtown area
- Minimum branch height: 7'-0" above the rootball

Parking lot and vehicular use area screening

- Seven (7) foot wide perimeter landscaped area (2 foot car overhang, 5 foot landscaped area)
- Continuous screening hedge, maintained between thirty (30) and forty-eight (48) inches height
- Tree planting required in perimeter landscaped area at a rate of one per twenty-five (25) feet of linear frontage.
- Flexibility in tree spacing for perimeter landscape area
- Ornamental metal fencing around new parking lots and other vehicular use areas (4 foot height typical; 6 foot height around secured parking lots), to be located five (5) feet from sidewalk in seven (7) foot perimeter landscaped area
- Ornamental metal fencing around existing parking lots and other vehicular use areas (heights per above):
 - Existing parking lots in greater downtown to add ornamental metal fencing by 2002
 - Existing parking lots above 100 spaces to add ornamental metal fencing by 2004
 - Existing parking lots above 4 spaces to add ornamental metal fencing by 2006
 - No requirements for existing parking lots of not-for-profit institutions
 - Fencing required only along public right-of-way; alleys not included
- Ornamental metal fencing required along lot lines adjacent to public streets
- Wall, fence, or hedge required along side or rear lot lines of properties contiguous with residential districts
- Chain-link fencing not permitted
- Hose bibbs required every one hundred (100) feet throughout perimeter landscape area

Summary of landscape requirements

Parking lot and vehicular use area internal planting

- Required landscaped area of parking lots and other vehicular use areas to vary as a function of size:
 - Parking lots below 3,000 SF: No internal landscaped area required
 - Parking lots between 3,000 and 4,500 SF: Internal landscaped area equal to five (5) percent of total area
 - Parking lots between 4,500 and 30,000 SF: Internal landscaped area equal to seven and one-half (7.5) percent of total area
 - Parking lots above 30,000 SF: Internal landscaped area equal to ten (10) percent of total area
- One (1) tree per 125 SF of required internal landscaped area, exclusive of tree planting required in perimeter landscape area -- see Chapter Two
- Four (4) inch minimum caliper trees within the "greater downtown" (see above)
- Two and one-half (2-1/2") inch minimum caliper trees outside the "greater downtown"
- Tree location, vehicular use areas below 4,500 SF: Required trees may be planted on perimeter
- Tree location, vehicular use areas above 4,500 SF: Required trees must be planted in internal islands
- Use of porous or permeable paving materials for overflow parking and other low use areas is encouraged
- Minimum two foot (2'-0") excavation below the parking surface
- Backfill internal islands with topsoil to top of curb, and mound topsoil up another six (6) inches above top of surrounding curb
- Use spreading canopy trees, to increase shade and reduce "urban heat island" effect

Parking structures and garages

- Trees, shrubs, groundcover, and perennial plantings must be planted in any required setback zone
- Vines may be required at the base of a parking structure, if so determined by the Department of Planning and Development
- One hundred percent of total linear footage of unscreened structure openings facing a public right-of-way is required to have perimeter planters, landscaped upper level setbacks, hanging baskets, flower boxes, or trellises with plants distributed along the entire length of the facade
- Unscrened openings facing residential uses or other sensitive conditions and not facing a public right-of-way may be required to have perimeter planting methods per above
- Uncovered parking on the top level of a parking structure shall require roof top planters around the entire perimeter of the top floor

Enhancements (planters, street furnishings, etc.)

- One (1) SF of sidewalk planter required per linear foot of public right-of-way frontage in areas where trees cannot be planted; sidewalk planters encouraged in other areas
- Rooftop perimeter planters required on all structures where the roof is usable space (i.e. access for building residents or users is encouraged)
- Six (6) foot height masonry screen wall required around dumpsters and other trash collection bins and areas, furnished with opaque, lockable gates, masonry walls with vines planted at the base

- One (1) outdoor-type dual-outlet receptacle required per sidewalk planter or tree, for seasonal lighting or decoration, in greater downtown and commercial use areas only

Growing medium

- Three foot (3'-0") minimum depth
- Three foot six inch (3'-6") minimum inside clear width; greater than five feet (5'-0") is desirable
- Soil composition: 45-77% silt, 0-25% clay, 25-33% sand
- Soil acidity: pH 6.0 to 7.0; amend soil as required to achieve this pH range
- Soil organic content: Three (3) to five (5) percent
- Parkway planters to be as long and as continuous as possible
- Minimum five feet (5'-0") from the inside edge of the planter or tree pit to the last tree in any series or group of trees
- Curbs and low railings to be installed around parkway planters throughout the "greater downtown," in commercial use areas, and in other heavy pedestrian traffic areas
- Percolation testing to be done prior to installation of any planting
- Soil testing of existing soils to be done prior to installation of any planting
- Soil testing of import soils to be done prior to installation of any planting
- Mechanical subsurface drainage required in areas with poor percolation and drainage rates
- Groundcover and low shrub planting required instead of grass, bark or gravel mulch, or other non-live materials
- "Structural soil" (e.g., "Cornell" mix, etc.) at a depth of two foot six inches (2'-6") and / or root paths required below sidewalk slabs between parkway planters and other planting areas or greenspace
- When sidewalks are replaced, "structural soil" or root paths are required below sidewalk slabs to permit root growth beyond small pit or cut-out in sidewalk
- Root paths may be used to connect trees planted in parkways (the distance from the back of the curb to the edge of the right-of-way) to adjacent greenspace

Maintenance

- All required landscaping on private property to be maintained throughout the life of the project; obligation assumed by subsequent owners
- All required landscaping within public right-of-way to be replaced, if needed, for a minimum of five (5) years by the original applicant and any subsequent owners. Responsibility for replacement will be assumed after five (5) years by the City of Chicago
- Rainfall to be supplemented with water for a total rate of one (1) inch per week during the growing seasons for the first three years
- Slow release (e.g. "gator") bags are recommended for supplemental watering
- Post public notice of landscape installation and maintenance requirements, in order to alert neighbors and concerned citizens to a project's landscape requirements
- All required landscaping to be replaced throughout the life of the project, as required; obligation assumed by subsequent owners

Summary of landscape requirements

Warranty

- All required landscaping on private property to be replaced throughout the life of the project, as required; obligation assumed by subsequent owners
- All required landscaping within public right-of-way to be replaced, if needed, for a minimum of five (5) years by the original applicant and any subsequent owners. Responsibility for replacement will be assumed after five (5) years by the City of Chicago

Submittals

- See Appendix B for a list of information required with landscape plans

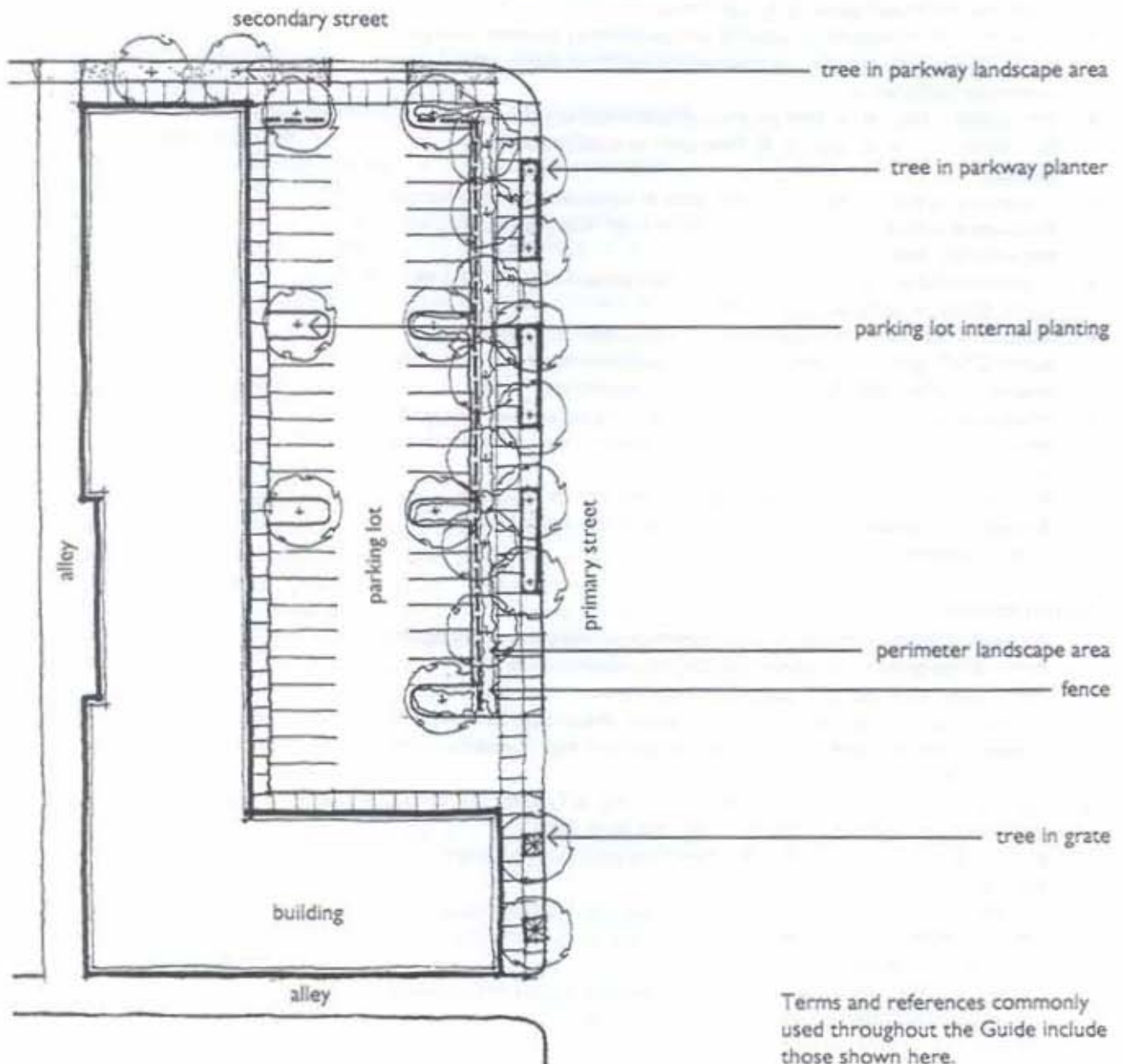

Terms and references commonly used throughout the Guide include those shown here.

There is a world of difference between a shady, green, tree-lined street, on the one hand, and a hot, treeless street dominated by paving, on the other hand. The principal difference between these two streets, and the perception of their attractiveness or unattractiveness, is the presence or lack of shade trees planted in the parkway. The parkway is measured from the back of the curb to the edge of the right-of-way. The parkway planting area is located between the back of curb and the sidewalk within the public right-of-way.

Parkway planting is the most typical requirement of landscape ordinances throughout the country. Parkway planting has been a requirement of Chicago's landscape ordinance from the beginning. This proposed revision of the landscape ordinance would not change the number of trees required, but would increase their size. In narrow sidewalk areas, or sidewalks where there is heavy pedestrian traffic, and trees must be planted in tree pits, or cut-outs within the paving, this proposed revision of the landscape ordinance would require that trees be protected by tree grates when they must be planted in tree pits. Use of tree guards, to protect trees further, would be encouraged, but not required.

Parkway planting requirements are explained and illustrated in detail in this section, and are summarized below:

- One (1) tree per twenty-five (25) linear feet (LF) of frontage on a public right-of-way
- Four (4) inch minimum caliper trees within the "greater downtown" (area bounded by North Avenue, Lake Michigan, Cermak Road, and Ashland Avenue)
- Two-and-one-half (2-1/2) inch minimum caliper trees outside the "greater downtown"
- All public building projects should, but are not required to, install four (4) inch minimum caliper trees, regardless of location relative to the "greater downtown"
- Continuous, open planters with continuous planting soil volumes are preferred
- Tree grates are required where trees are planted in sidewalk openings; use of grates made from recycled materials is encouraged
- Structural soil or root paths are required below sidewalks when tree grates are used
- Black lava rock mulch and 18 gauge galvanized hard wire mesh are required in tree pits below tree grates in the greater downtown area
- Minimum branch height: 7'-0" above the rootball

Illustration

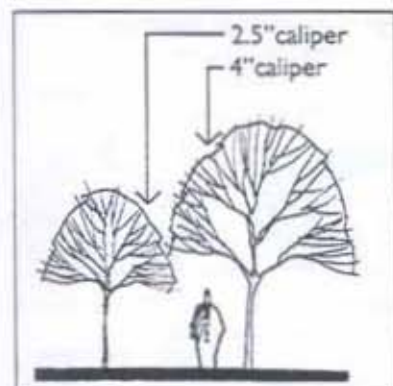

Requirement

- Trees planted outside the greater downtown area (North Avenue, Lake Michigan, Cermak Road, Ashland Avenue) are to be 2.5" minimum caliper
- Trees planted within greater downtown area are to be 4" minimum caliper
- All public building projects should, but are not required to, install four (4) inch minimum caliper trees, regardless of location relative to the "greater downtown"



Parkway trees help improve the visual character of a neighborhood while reducing glare and heat from the sun.



Parkway planting

Illustration

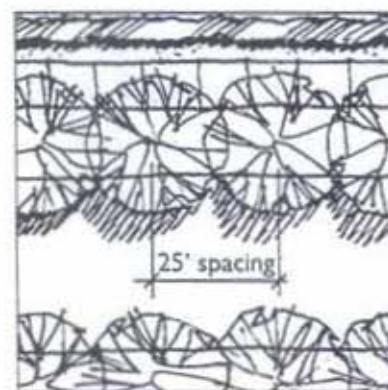
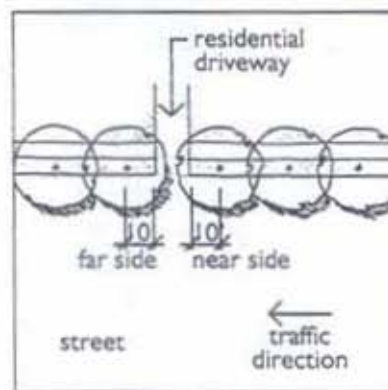
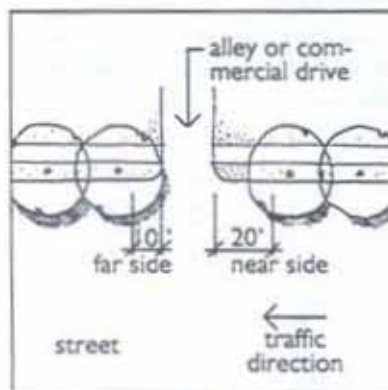
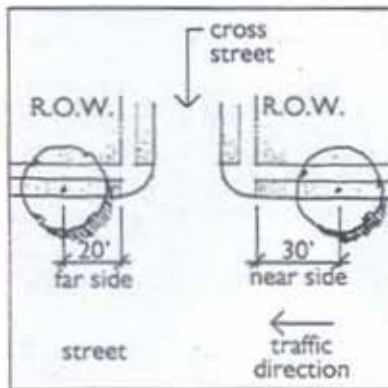

Requirement

- Street trees must be at least 30' from the right-of-way (R.O.W.) line or property line on the side of the street intersection closer to an automobile driver ("near side")
- Street trees must be at least 20' from the right-of-way (R.O.W.) line or property line on the side of the street intersection farther from an automobile driver ("far side")
- Street trees must be at least 20' from the edge of an alley or commercial drive on the side of the street intersection closer to an automobile driver ("near side")
- Street trees must be at least 10' from the edge of an alley or commercial drive on the side of the street intersection farther from an automobile driver ("far side")
- Street trees must be at least 10' from the edge of a residential driveway on the side of the street intersection closer to an automobile driver ("near side")
- Street trees must be at least 10' from the edge of a residential driveway on the side of the street intersection farther from an automobile driver ("far side")
- One tree per 25 linear feet (LF) of frontage is required in parkways

Illustration

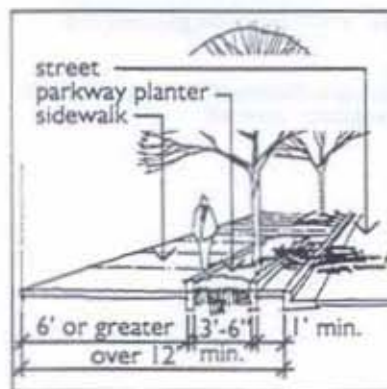
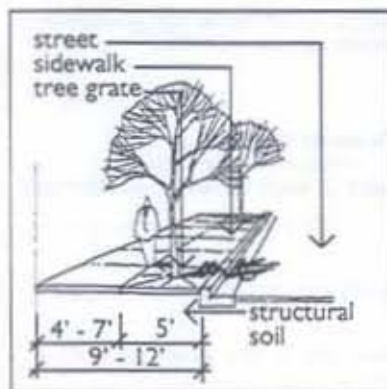
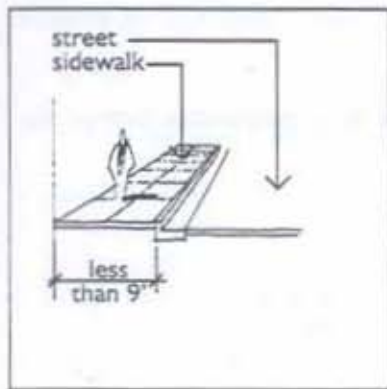

Requirement

- Where the parkway (the distance from the back of the curb to the edge of the right-of-way) is less than or equal to 9 feet wide, no street tree is required
- Other enhancements (planters, etc.) are required; see Chapter Five
- Where the parkway (the distance from the back of the curb to the edge of the right-of-way) is between 9 and 12 feet wide, street trees must be planted using a tree grate to provide adequate room for pedestrians
- Street trees planted with tree grates must be planted in topsoil backfill with structural soil placed between tree pits under pavement areas; see Chapter Six and Appendix E
- Where the parkway (the distance from the back of the curb to the edge of the right-of-way) is more than 12 feet wide, street trees must be planted in a continuous parkway planter
- Planters must be at least 3'-6" wide (inside-to-inside of perimeter curb)
- The use of structural soil may be required under sidewalks outside of the parkway planter; see Chapter Six and Appendix E
- When diagonal parking is designed and constructed within the parkway, existing trees in the parkway are to be saved by incorporating them into islands
- New trees are to be planted in islands at both ends of the parking area in unusable end islands, provided 30' near side and 20' far side setbacks are met
- Planting islands in diagonal parking areas must be spaced no further than fifteen (15) parking spaces apart

Parkway planting

Illustration

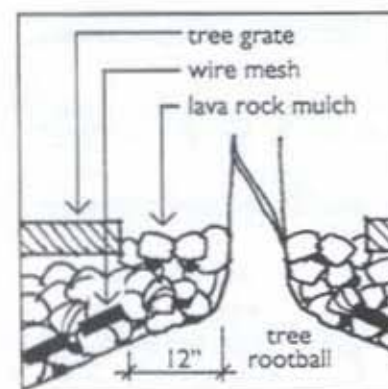
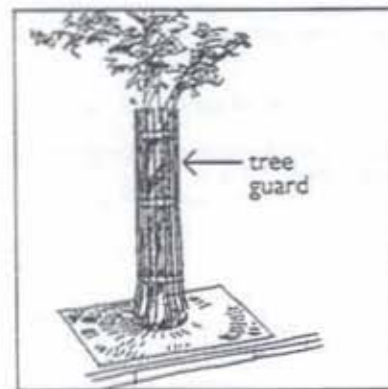
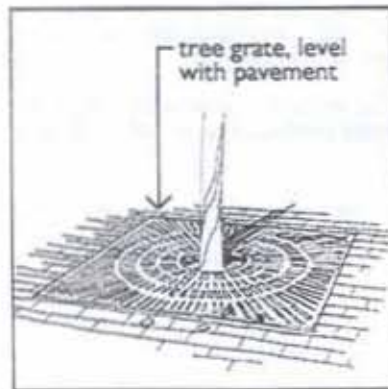
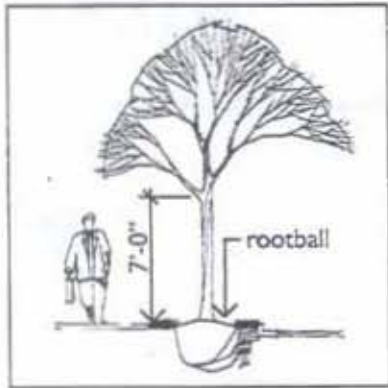

Requirement

- Minimum branch height in the Greater Downtown Area: 7'-0" as measured from the top of the rootball
- Minimum branch height in all other areas: 6'-0" as measured from the top of the rootball

- Tree grates are required where trees required by the landscape ordinance are planted in sidewalk opening (i.e. no open pits are allowed)
- Opening at trunk must be expandable
- No uplighting can be located below grade under the grate
- If conduit for electric receptacle is provided, it must run over, not through, the root ball

- Tree guards are allowed, but not required, where trees are planted in a sidewalk opening with a tree grate
- Tree guards may only be used where there is a history of damage to street trees; they are not to be used purely for aesthetic reasons

- In greater downtown area only, black lava rock mulch is required in tree pits with tree grates
- Lava rock to be of a minimum depth to just fill void between rootball and tree grate
- In greater downtown area only, eighteen (18) gauge hard wire mesh required for rodent control
- Wire mesh to have an opening around the tree trunk of 12" to allow trunk growth

In order to protect trees and their root systems, new parkway trees must be located no closer than the following distances from walks, curbs, utilities, and other structures in the parkway:

<u>Structure</u>	<u>Distance</u>
Curbs (measured from vertical face)	2' - 0"
Building exits	5' - 0"
Courtesy walks	5' - 0"
Fire hydrants	5' - 0"
Manholes and catchbasins	5' - 0"
Wall hydrants, standpipes	5' - 0"
Siamese connections	5' - 0"
Buildings	10' - 0"
Fire escapes	10' - 0"
Street lights	12' - 0"
Trees (fastigate or columnar forms)	20' - 0"
Pedestrian overpasses and tunnels	25' - 0"
Trees (existing)	25' - 0"
Other structures (unless directed otherwise)	25' - 0"
Bus stop (near side of intersection)	40' - 0"
Railroads (with approval)	50' - 0"
Viaducts (with approval)	50' - 0"
Bus stop (far side of intersection)	75' - 0"

One of the least favorable impressions from a street is the sense of passing through a sea of parking. In a residential district, parking lots are unattractive intrusions that diminish the appearance and the value of the adjacent residential property. In a commercial district parking lots are the lifeblood of retail and other commercial activity, but they play a supporting, not a principal role, and should not be the dominant impression of a retail corridor or neighborhood commercial district. Parking lots are similarly important to manufacturing and industrial uses, but they exist to provide parking for employees and visitors, and are not the principal use.

Screening of parking lots and other vehicular use areas (trailer parking and storage, service areas, outdoor storage, etc.) is a typical requirement of landscape ordinances throughout the country. Screening of parking lots and vehicular use areas has been a requirement of Chicago's landscape ordinance from the beginning. This updated landscape ordinance does not change the location or size of screening required. It does, however, increase the size of the required landscaped setback, in order to provide a more favorable environment for plant growth, and also adds a requirement for a row of trees to be planted around the perimeter of parking lots and vehicular use areas.

New parking lot and vehicular use area screening requirements are explained and illustrated in detail in this section, and are summarized below:

- Seven (7) foot wide perimeter landscaped area (2 foot car overhang, 5 foot landscaped area)
- Continuous screening hedge, maintained between thirty (30) and forty-eight (48) inches height
- Live groundcover is recommended in car overhang area where maintenance will be provided; otherwise grass or non-live material, such as gravel, mulch or paving, are required
- Tree planting required in perimeter landscaped area (same spacing or quantity as parkway planting, one (1) per 25 LF)
- Flexibility in tree spacing (groupings of trees permitted, not only regular spacing)

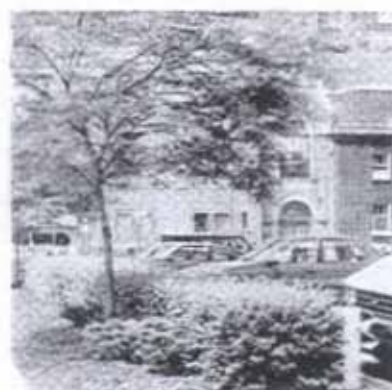

Wider planting beds around the perimeter of vehicular use areas will improve the number and health of plants used to screen parked vehicles.

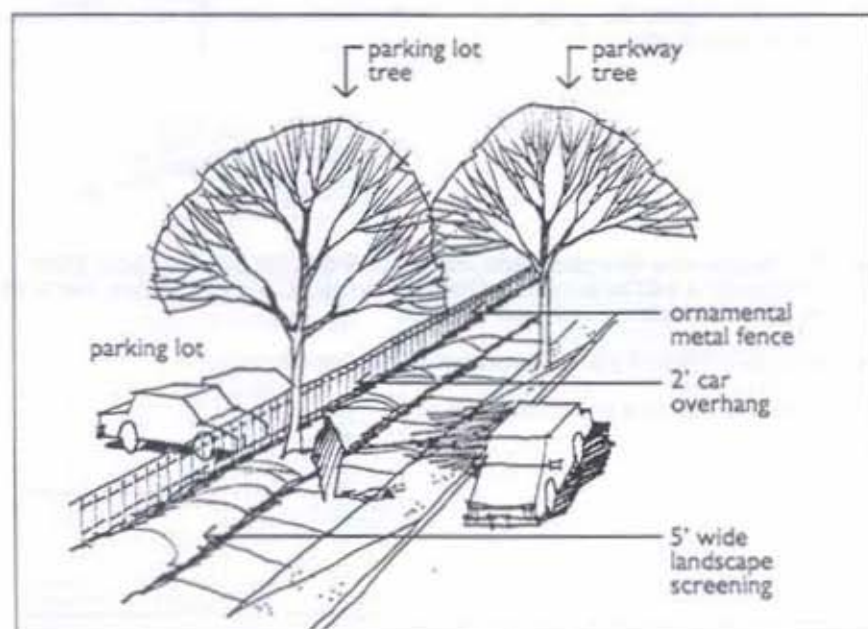

Parking lots should be screened from adjacent sidewalks and streets to improve the aesthetic quality of each.

Parking lot and vehicular use area screening

- Ornamental metal fencing around new parking lots and other vehicular use areas (4 foot height typical; 6 foot height around secured parking lots), to be located five (5) feet from sidewalk in seven (7) foot perimeter landscaped area
- Ornamental metal fencing around existing parking lots and other vehicular use areas (heights per above):
 - Existing parking lots in greater downtown to add ornamental metal fencing by 2002
 - Existing parking lots above 100 spaces to add ornamental metal fencing by 2004
 - Existing parking lots above 4 spaces to add ornamental metal fencing by 2006
 - No requirements for existing parking lots of not-for-profit institutions
 - Fencing required only along public right-of-way; alleys not included
- Ornamental metal fencing required along lot lines adjacent to public streets
- Landscape screening required adjacent to residential districts and institutional uses
- Wall, fence, or hedge required along side or rear lot lines of properties contiguous with residential districts
- Chain-link fencing not permitted
- Hose bibbs required every one hundred (100) feet throughout perimeter landscape area

Illustration

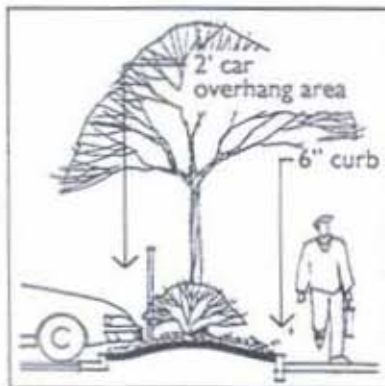
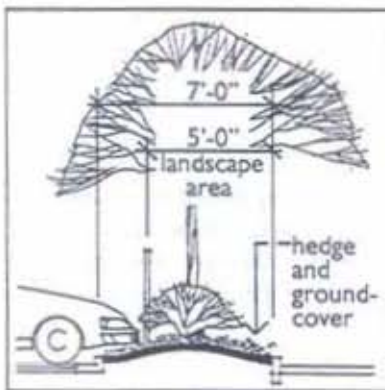

Requirement

- 7' wide perimeter landscape area (2' car overhang, 5' landscape area) measured from the right-of-way line (public land cannot be counted toward the fulfillment of this obligation)
- 5' wide landscape area with continuous hedge (36-48" mature / maintained height) and groundcover or additional plant material
- Soil to be placed for entire width of 7' perimeter landscape area, including car overhang area
- Groundcover or live planting is recommended in car overhang area where maintenance will be provided. Otherwise grass or non-living materials such as gravel, mulch or paving are required
- 6" curb at back of sidewalk recommended, but not required
- Soil below surface in car overhang area

Parking lot and vehicular use area screening

Illustration

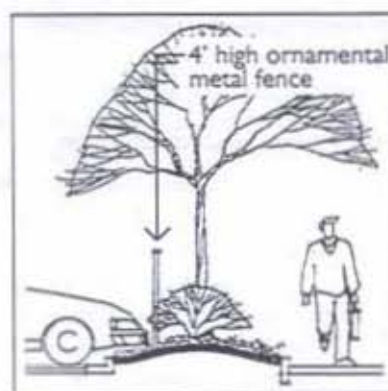

Requirement

- Tree planting required: 1 tree per 25 LF of perimeter landscape area
 - Tree spacing not required to be equal; groupings with tighter spacing and larger openings between groupings is permitted
 - Stagger or offset trees with parkway trees
 - Trees planted in the perimeter landscape area are a separate requirement, and do not count toward either the parkway planting or the vehicular use area internal planting requirements
-
- Continuous screening hedge, 30 to 48 inches high
-
- New vehicular use areas are required to have ornamental metal fencing as follows:
 - 4' foot minimum height
 - 5' setback from sidewalk within 7 foot perimeter landscape area
-
- Existing vehicular use areas without ornamental metal fencing are required to have ornamental metal fencing as follows:
 - within the greater downtown area (North Avenue, Lake Michigan, Cermak Road, Ashland Avenue) by 2002
 - parking lots above 100 spaces by 2004
 - parking lots above 4 spaces by 2006

Parking lot and vehicular use area screening

Illustration

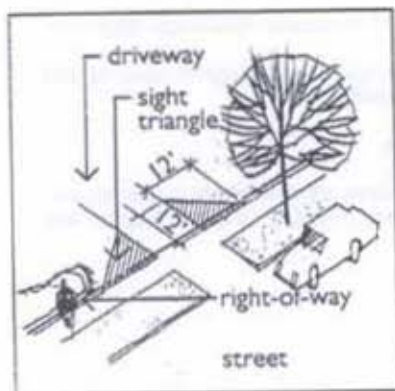

Requirement

- No landscaping above 30" in height is to be located within a 12' sight triangle as measured from the right-of-way

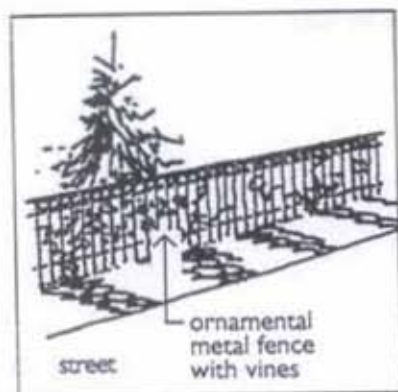

- Ornamental metal fencing or landscape screening is required adjacent to residential and institutional uses
- Ornamental metal fencing is required along lot lines adjacent to public rights-of-way
- Chainlink fencing is not permitted
- Vine planting is recommended on, or at the base of, required perimeter fencing
- Minimum five (5) foot setback from property line to the fence

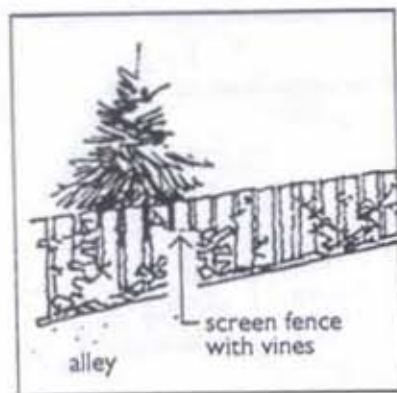

- Opaque fencing or landscape screening is required adjacent to residential and institutional uses
- Chainlink fencing is not permitted
- Vine planting is recommended on, or at the base of, required perimeter fencing

Parking lots and other vehicular use areas may be developed as no more than unrelieved expanses of asphalt paving. Such parking lots are unattractive, hot, and bright in the summer, and are contributing factors to the "urban heat island" phenomenon whereby urban areas are significantly warmer, less comfortable, and less healthy than areas dominated by trees, greenery, and open space. Parking lots may also be developed as "parking gardens," with trees planted in islands and circulation drives flanked by landscaped areas planted with trees, shrubs, and perennials.

Planting trees around, but especially within parking lots and other vehicular use areas is a typical requirement of landscape ordinances throughout the country. Requiring landscaped areas within parking lots, and requiring trees within those landscaped areas, has been a requirement of Chicago's landscape ordinance from the beginning. It affects the amount of landscaped area, the number of trees required, and the attention given to proper excavation, topsoil backfill, and planting of trees, shrubs, and other plants in what is generally an inhospitable environment for plants.

Proposed parking lot and vehicular use area internal planting requirements are explained and illustrated in detail in this section, (exclusive of seven foot wide perimeter landscape area -- see Chapter Two) and are summarized below:

- Required landscaped area of parking lots and other vehicular use areas to vary as a function of size:
 - Parking lots below 3,000 SF: No internal landscaped area required
 - Parking lots between 3,000 and 4,500 SF: Internal landscaped area equal to five (5) percent of total area
 - Parking lots between 4,500 and 30,000 SF: Internal landscaped area equal to seven and one-half (7.5) percent of total area
 - Parking lots above 30,000 SF: Internal landscaped area equal to ten (10) percent of total area
- One (1) tree per 125 SF of required internal landscaped area (exclusive of tree planting required in perimeter landscape area -- see Chapter Two)
- Four (4) inch minimum caliper trees within the "greater downtown" (see above)
- Two and one-half (2-1/2") inch minimum caliper trees outside the "greater downtown"
- Tree location, vehicular use areas below 4,500 SF: Required trees may be planted on perimeter
- Tree location, vehicular use areas above 4,500 SF: Required trees must be planted in internal islands
- Use of porous or permeable paving materials for overflow parking and other low use areas is encouraged
- Minimum two foot (2'-0") excavation below the parking surface
- Backfill internal islands with topsoil to top of curb, and mound topsoil up another six (6) inches above top of surrounding curb
- Use spreading canopy trees, to increase shade and reduce "urban heat island" effect



Internal islands of parking lots should be planted with shade trees and groundcover to improve the aesthetic quality of the lot while reducing heat and glare from the sun.

Parking lot and vehicular use area internal planting

Illustration

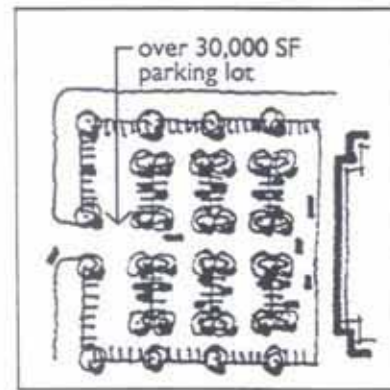
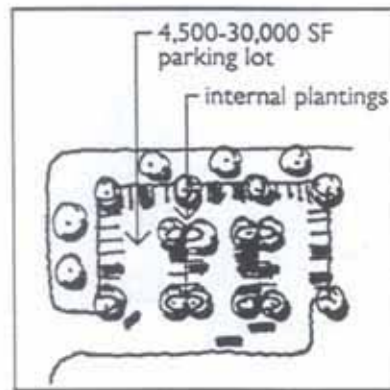
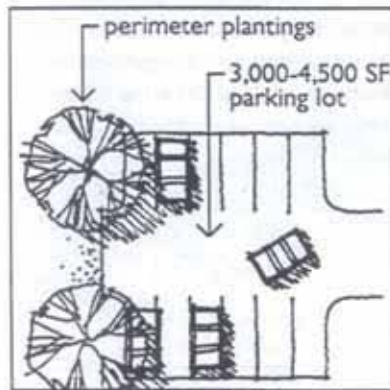
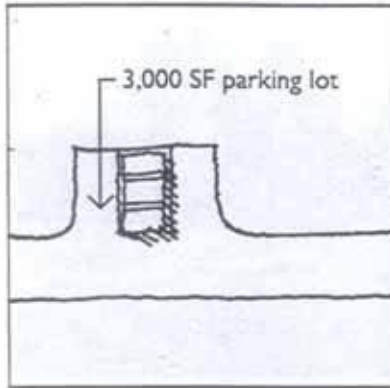

Requirement

- Vehicular use areas smaller than 3,000 square feet (SF) do not require any landscape area
- Vehicular use areas between 3,000 and 4,500 SF require a landscape area equal to 5 percent of the total area of the vehicular use area
- Vehicular use areas under 4,500 SF are not required to have trees planted in internal areas of the vehicular use area
- Required trees are allowed to be planted in perimeter landscape areas
- Vehicular use areas between 4,500 and 30,000 SF require a landscape area equal to 7.5 percent of the total area of the vehicular use area
- Vehicular use areas over 4,500 SF are required to have trees planted in internal areas of the vehicular use area
- Vehicular use areas over 30,000 SF require a landscape area equal to 10 percent of the total area of the parking lot
- Vehicular use areas over 4,500 SF are required to have trees planted in internal areas of parking lot

Parking lot and vehicular use area internal planting

Illustration

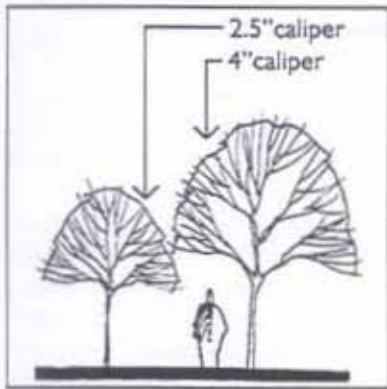

Requirement

- Trees planted within the greater downtown area (North Avenue, Lake Michigan, Cermak Road, Ashland Avenue) are to be 4" minimum caliper
- Trees planted outside the greater downtown area are to be 2.5" minimum caliper

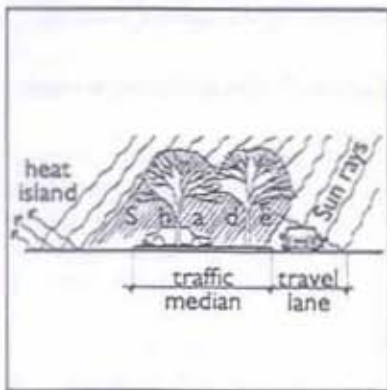

- Use of spreading canopy trees is encouraged to increase shade and reduce "urban heat island" effect
- Trees are required to be planted in internal islands

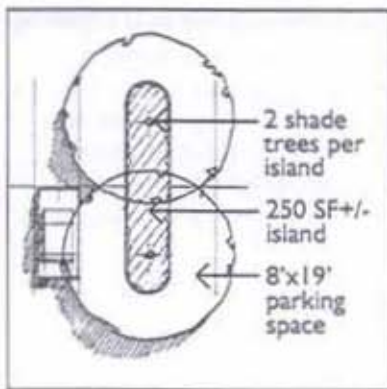

- One tree is required for each 125 square feet (approximately equal to the inside dimensions of a standard parking space) of required landscape area, exclusive of tree planting required in perimeter landscape area -- see Chapter Two
- See Appendix D for additional information regarding tree planting in parking lot islands

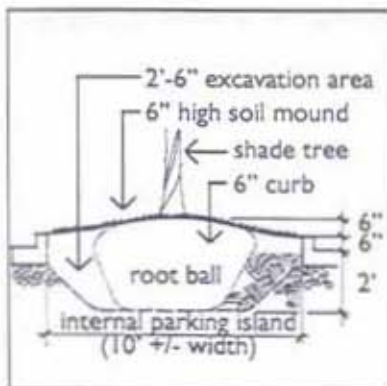

- A minimum excavation of 2 feet below the paving surface
- Topsoil backfill should be level with the top of curb
- Topsoil should be mounded up an additional 6" in vehicular use area internal islands

Parking lot and vehicular use area internal planting

Illustration

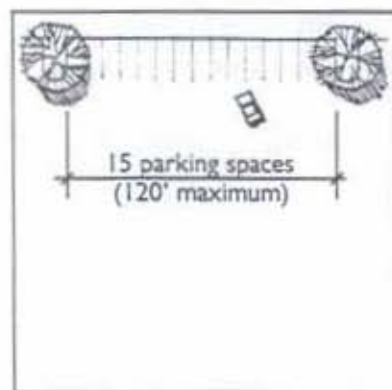
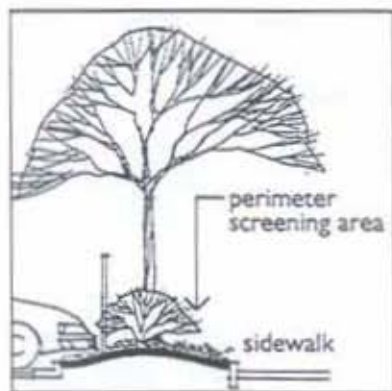
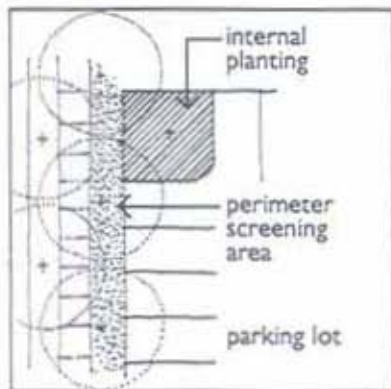

Requirement

- Corner islands may be counted toward internal planting requirements even though they are contiguous with perimeter screening areas
- Seven (7) foot perimeter setback does not count toward internal planting requirements
- Landscape perimeter setback in excess of seven (7) feet will count toward internal planting requirements
- Internal planting islands must be spaced no farther than fifteen (15) parking spaces apart.
- The use of porous or permeable paving materials for overflow parking and other low use areas is encouraged

Parking structures, unless designed and developed with sensitivity to their surroundings, can overwhelm the scale of a street and create a very poor pedestrian environment. In recognition of the importance of good planning and design for parking structures, the City of Chicago passed the Parking Garage Ordinance in 1999. The ordinance requires design review by the Department of Planning and Development (DPD) for all structures containing two or more parking levels above grade. Design guidelines for parking structures based on the ordinance are available from the DPD.

The ordinance promotes parking structures that screen both cars and sloped floors from view. Parkway landscaping is a critical component of enhancing the design of parking garages. Garages without ground floor retail or residential uses should have a ten to twenty foot, densely-planted setback area at grade for screening. Upper floors that are not otherwise screened will be required to provide perimeter planters within openings, upper-level landscaped setbacks, hanging baskets, flower boxes, or planting trellises on facades facing public streets or facing sensitive neighborhood conditions. All garage structures with uncovered parking on the top level shall provide rooftop planters around the perimeter. Vines planted at the base of the structure may be required as well.

Landscape requirements for parking structures without retail at grade and/or unscreened upper floor openings are explained and illustrated in detail in this section, and are summarized below:

- Trees, shrubs, groundcover, and perennial plantings must be planted in any required setback zone
- Vines may be required at the base of a parking structure, if so determined by the Department of Planning and Development
- One hundred percent of total linear footage of unscreened structure openings facing a public right-of-way is required to have perimeter planters, landscaped upper level setbacks, hanging baskets, flower boxes, or trellises with plants distributed along the entire length of the facade
- Unscreened openings facing residential uses or other sensitive conditions and not facing a public right-of-way may be required to have perimeter planting methods per above
- Uncovered parking on the top level of a parking structure shall require roof top planters around the entire perimeter of the top floor



Parking structures and garages can be significantly improved with the planting of shrubs, flowers, and vines along the perimeter.



Parking structures and garages

Illustration

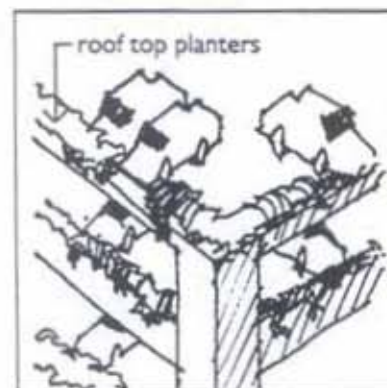
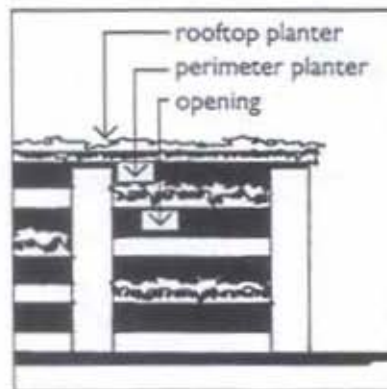
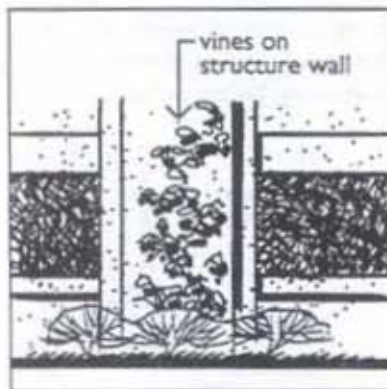
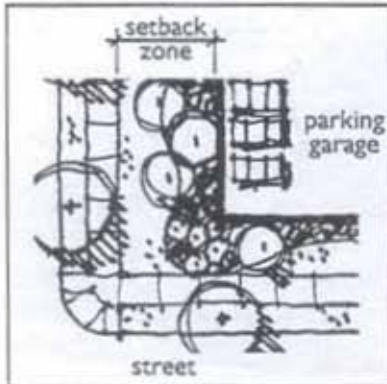

Requirement

- Trees, shrubs, groundcover, and perennial plantings must be planted in any required setback zone
- Vines may be required at the base of a parking structure, if so determined by the Department of Planning and Development
- One hundred percent of total linear footage of unscreened structure openings facing a public right-of-way is required to have perimeter planters, landscaped upper level setbacks, hanging baskets, flower boxes, or trellises with plants distributed along the entire length of the facade
- Unscrened openings facing residential uses or other sensitive conditions and not facing a public right-of-way may be required to have perimeter planting methods per above
- Uncovered parking on the top level of a parking structure shall require roof top planters around the entire perimeter of the top floor

There exists an opportunity to enhance the basic landscape requirements reviewed in the preceding sections, or to substitute other landscape treatments where parkway trees and other treatments cannot be accommodated. Such enhancements or substitute treatments include, but are not limited to, sidewalk planters, rooftop perimeter planters, screen walls around dumpster and garbage enclosures, and electrical receptacles in tree pits and planters to accommodate seasonal lighting displays.

Requirements for streetscape and landscape enhancements are explained and illustrated in detail in this section, and are summarized below:

- One (1) SF of sidewalk planter required per linear foot of public right-of-way frontage in areas where trees cannot be planted; sidewalk planters encouraged in other areas (e.g. if parcel has 50' of frontage, 50 SF of planter required: six 3'x3' planters would satisfy the requirement)
- Rooftop perimeter planters required on all structures where the roof is usable space (i.e. access for building residents or users is encouraged)
- Six (6) foot height masonry screen wall required around dumpsters and other trash collection bins and areas, furnished with opaque, lockable gates, masonry walls with vines planted at the base
- One (1) outdoor-type dual-outlet receptacle required per sidewalk planter or tree, for seasonal lighting or decoration, in greater downtown and commercial use areas only



By adding trees, planters, benches, lighting, banners, and special paving to sidewalks, urban areas will be greatly enhanced.

Enhancements

Illustration

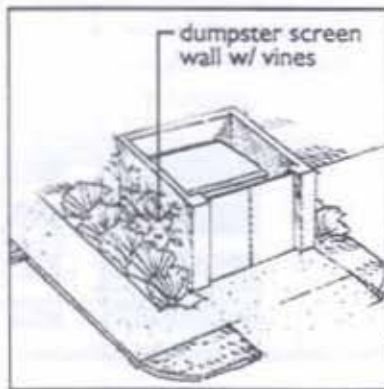

Requirement

- One (1) SF of sidewalk planter required per linear foot of public right-of-way frontage in areas where trees cannot be planted; sidewalk planters encouraged in other areas (e.g. if parcel has 50' of frontage, 50 SF of planter required; six 3'x3' planters would satisfy the requirement)
- Sidewalk planters in the public right-of-way are to be maintained throughout the life of the project by the owner; maintenance obligation must transfer to subsequent owners
- All planters in the public right-of-way are considered "structures" and, as such, require a permit from the Chicago Department of Transportation (CDOT) Bureau of Streets
- Planters shall have a minimum size of 3' square or 3' diameter
- Planters shall have a minimum height of 2' and a maximum height of 3'
- Rooftop perimeter planters are required on all structures where trees cannot be planted in the public right-of-way
- Rooftop perimeter planters are required on all structures where the roof is usable space
- A six (6) foot height masonry screen wall is required around dumpsters and other trash collection bins and areas
- Enclosures are to be furnished with opaque, lockable gates and masonry walls planted with vines
- Vines are to be planted in planting beds (12" wide minimum) around the perimeter of the masonry walls
- It is encouraged that additional plants be planted in the perimeter planting beds

The quality of the soil and the overall design of the planter area are the literal foundation for successful landscaping. Plants require an adequate volume of topsoil which has the necessary nutrients, a minimum percentage of organic matter, and soil acidity in a defined range. The soil must be well-drained and protected from compaction which prevents water and air from reaching the root zone of plants.

Requirements for growing medium and parkway planter design are explained and illustrated in detail in this section, and are summarized below:

- Three foot (3'-0") minimum depth
- Three foot six inch (3'-6") minimum inside clear width; greater than five feet (5'-0") is desirable
- Soil composition: 45-77 percent silt, 0-25 percent clay, 25-33 percent sand
- Soil acidity: pH 6.0 to 7.0; amend soil as required to achieve this pH range
- Soil organic content: Three (3) to five (5) percent
- Parkway planters to be as long and as continuous as possible
- Minimum five feet (5'-0") from the inside edge of the planter or tree pit to the last tree in any series or group of trees
- Curbs and low railings to be installed around parkway planters throughout the "greater downtown," in commercial use areas, and in other heavy pedestrian traffic areas
- Percolation testing to be done prior to installation of any planting
- Mechanical subsurface drainage required in areas with poor percolation and drainage rates
- Groundcover and low shrub planting required instead of grass, bark or gravel mulch, or other non-live materials
- "Structural soil" (e.g., "Cornell" mix, etc.) at a depth of two foot six inches (2'-6") and / or root paths required below sidewalk slabs between parkway planters and other planting areas or greenspace
- When sidewalks are replaced, "structural soil" or root paths are required below sidewalk slabs to permit root growth beyond small pit or cut-out in sidewalk
- Root paths may be used to connect trees planted in parkways (the distance from the back of the curb to the edge of the right-of-way) to adjacent



Healthy, vigorous roots will be likely to grow when proper attention is given to the volume and nutrient content of soil.

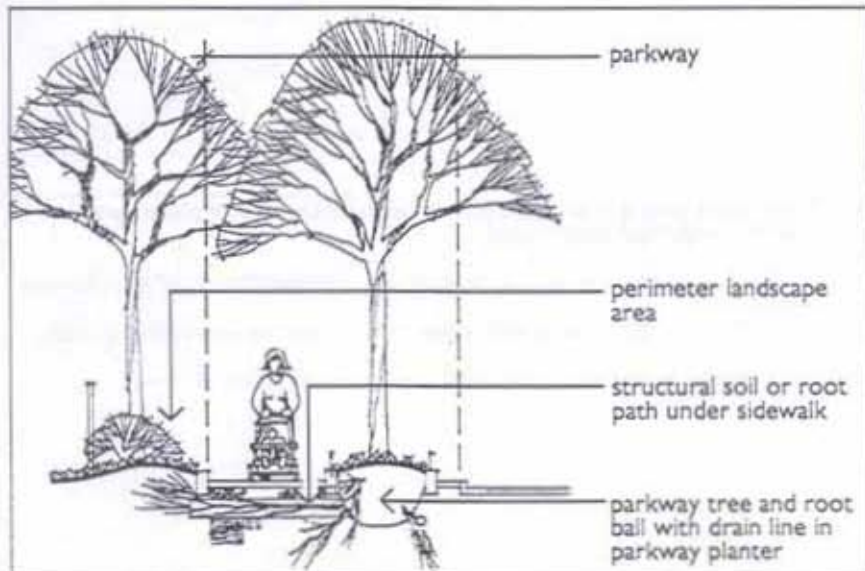

By making unpaved areas of parkways as large as possible and providing structural soil or root paths when trees are planted, the health and longevity of the trees will be significantly improved.

Growing medium

Illustration

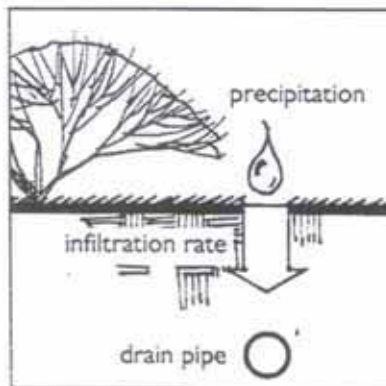
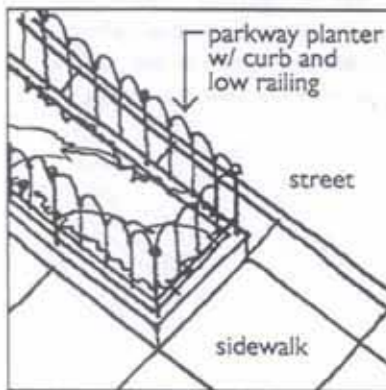
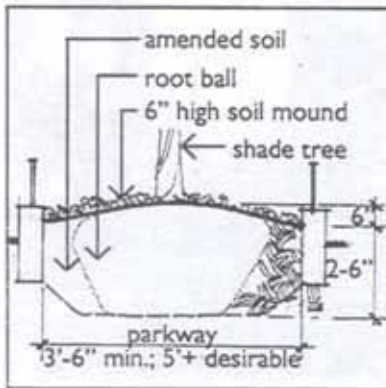

Requirement

- Three (3) foot minimum depth
 - Three foot six inch (3'-6") minimum inside clear width; greater than five feet (5') is desirable
 - Soil composition: 45-77 percent silt, 0-25 percent clay, 25-33 percent sand
 - Soil acidity: pH 6.0 to 7.0
 - Soil organic content: Three (3) to five (5) percent
-
- Planters in the parkway (the distance from the back of the curb to the edge of the right-of-way) are to be as long and as continuous as possible
 - Curbs and low railings to be installed around parkway planters throughout the "greater downtown," in commercial use areas, and in other heavy pedestrian traffic areas
 - Groundcovers and low shrubs are required instead of grass, bark or gravel mulch, or other non-organic materials
-
- Minimum five feet (5'-0") from the inside edge of the planter or tree pit to the last tree in any series or group of trees
-
- Percolation testing is required prior to installation of any planting to establish water infiltration rates
 - Soil testing of existing soils to be done prior to installation of any planting
 - Soil testing of import soils to be done prior to installation of any planting
 - Soils should be amended as needed to provide adequate drainage

Illustration

Requirement

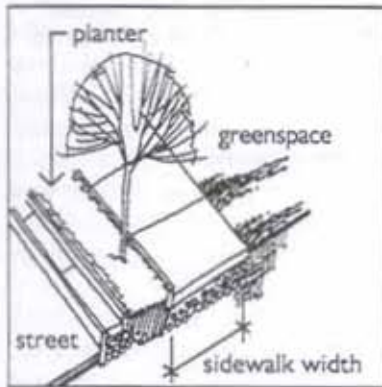

- Structural soil or root paths are not required if the sidewalk width is 6' or less where trees are planted in continuous planters in parkways and there is greenspace on the other side of the sidewalk
- Structural soil (minimum depth of 2'-6") or root paths are required under the sidewalk if the sidewalk width is greater than 6' where trees are planted in continuous planters in parkways and there is greenspace on the other side of the sidewalk

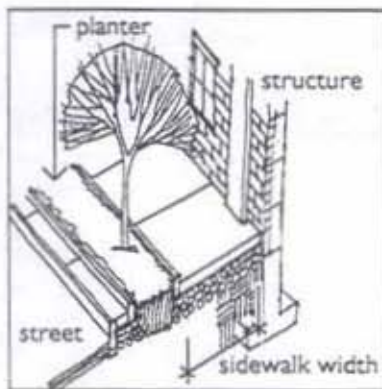

- Structural soil (minimum depth of 2'-6") is required under the sidewalk regardless of sidewalk width where trees are planted in continuous planters in parkways and there is a structure on the other side of the sidewalk
- In such cases, root paths are not allowed except to link the parkway planters to each other

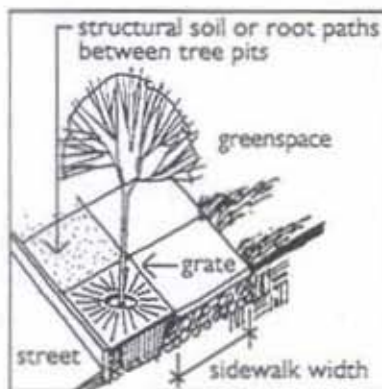

- Structural soil or root paths are not required between tree pits and the greenspace if the sidewalk width is 6' or less where trees are planted in tree pits with grates in parkways and there is greenspace on the other side of the sidewalk
- Structural soil (minimum depth of 2'-6") or root paths are required between tree pits and the greenspace if the sidewalk width is greater than 6' where trees are planted in tree pits with grates in parkways and there is greenspace on the other side of the sidewalk
- In all cases involving tree pits with grates, structural soil or root paths are required between the pits

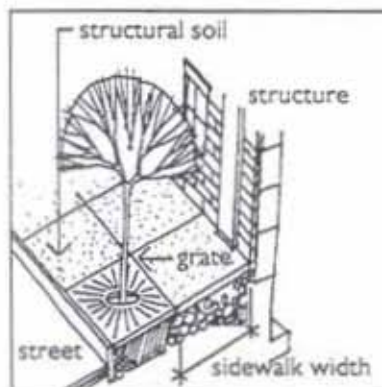

- Structural soil (minimum depth of 2'-6") is required regardless of sidewalk width where trees are planted in tree pits with grates in parkways and there is a structure on the other side of the sidewalk
- In such cases, root paths are not allowed except to link the tree pits to each other

Growing medium

Illustration

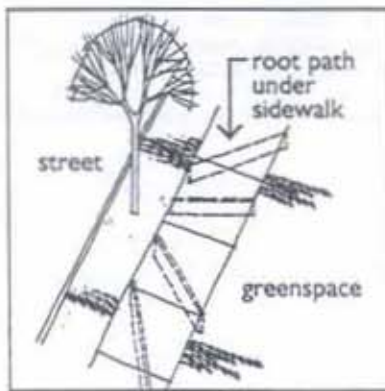
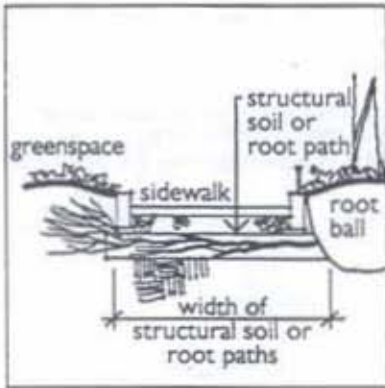

Requirement

- When sidewalks are replaced, "structural soil" or root paths are required below sidewalk slabs to permit root growth beyond small pit or cut-out in sidewalk
 - See Appendix D for planting details
 - See Appendix E for information regarding structural soil
-
- Root paths may be used to connect trees planted in parkways (the distance from the back of the curb to the edge of the right-of-way) to adjacent greenspace
 - Root paths should be placed no more than four feet (4') on center in a radial pattern from each tree to the adjacent greenspace

greenspace

Maintenance and warranty on plants which have been installed are the complementary requirements for successful landscaping. Plants cannot be installed and left alone to their own devices, especially in the problematic urban environment where plants are subject to poor soils, soil compaction, poor drainage, and physical abuse, so required maintenance is a necessary component of a successful landscape installation. Given the stresses and rigors to which plants are subjected, and occasionally owing to owners' neglect of required landscaping, plants have to be replaced, and a replacement warranty is also a necessary component of a successful landscape installation, as well as a good incentive to encourage proper plant maintenance.

Landscape maintenance and a replacement warranty are typical requirements of landscape ordinances throughout the country, although most ordinances simply have a maintenance requirement stated, but no detail on the particular requirements such as watering, weeding, fertilization, pruning, inspection and treatment for insects and diseases, etc. Landscape maintenance, including a requirement for replacement of dead or declining plants, has been a requirement of Chicago's landscape ordinance from the beginning. This proposed revision of the landscape ordinance would be more specific with respect to the actual tasks and schedule of landscape maintenance to be followed, in order to ensure that plants, once installed, have the best chance to grow and prosper.

Requirements for landscape maintenance are as follows:

- All required landscaping on private property to be maintained throughout the life of the project; obligation assumed by subsequent owners
- All required landscaping within public right-of-way to be replaced, if needed, for a minimum of five (5) years by the original applicant and any subsequent owners. Responsibility for replacement will be assumed after five (5) years by the City of Chicago
- Rainfall to be supplemented with water for a total rate of one (1) inch per week during the growing seasons for the first three years
- Slow release (e.g. "gator") bags are recommended for supplemental watering
- Post public notice of landscape installation and maintenance requirements, in order to alert neighbors and concerned citizens to a project's landscape requirements
- All required landscaping to be replaced throughout the life of the project, as required; obligation assumed by subsequent owners



Thorough maintenance on a consistent basis is a critical component of a healthy landscape.

Ascending: Upright, spreading tree form.

Basal clearance: Distance from the trunk to the drip line at maturity.

Botanical name: The Latin scientific name of a plant, a binomial consisting of "genus" and "species"; each plant has a unique botanical name.

Caliper: Outside diameter of a tree trunk, measured at 6" above ground for trees of less than 4" caliper, and measured at 12" above ground for trees of 4" or more.

Columnar: Narrow, upright tree form (see also "fastigate").

Common name: The English name of a plant; there is often more than one common name to a plant, or one common name shared by several plants, leading to confusion.

Container: Structure having sides and bottom, sitting on the sidewalk, filled with soil, used for planting, especially where paving or utilities preclude planting in the natural ground.

Courtesy walk: Narrow walk (usually 2'-6" or 3'-0") crossing the planted part of the parkway, connecting the curb to the sidewalk.

Deciduous: Plants shedding or losing foliage at the end of the growing season.

Dripline: Imaginary line at the outermost edge of the tree canopy. Minimum distance from trunk at which protective fencing is to be maintained.

Evergreen: Plants having foliage that persists and remains green all year.

Far side: A relative term, dependent upon traffic direction, referring to that part of an intersection across (on the far side of) the intersecting street from the driver's point of view.

Fastigate: Narrow, upright tree form (see also "columnar").

Groundcover: Low-growing plants, usually no higher than 12" or 18".

Internal planting: An area inside the perimeter of a parking lot used for landscaping.

Landscaped area: An area the ground of which is completely covered with grass, groundcover, shrubs, trees, or other living plant material.

Multi-stem: A tree form characterized by several trunks, or stems, rather than a single trunk. Examples include birch and alder.

Near side: A relative term, dependent upon traffic direction, referring to that part of an intersection before (on the near side of) the intersecting street from the driver's point of view.

Ornamental tree: Deciduous tree, mature height less than 30', possessing qualities such as flowers, fruit, and attractive foliage or shape.

Definitions

Parkway: That portion of the public way between the street and the nearest parallel property line, including sidewalk area.

Parkway landscape area: An area between the sidewalk and the back of street curb used for landscaping.

Parkway planter: A large planter cut-out in a sidewalk, usually edged with a concrete curb and /or metal fence located in the parkway landscape area.

Parkway tree: A permitted shade or ornamental tree planted in the parkway.

Perimeter landscape area: The seven foot-wide area of a site measured inward from the property line.

Perimeter planter: A planter located along the outer edge of a building, usually a parking structure.

Rooftop planter: A perimeter planter on the roof of a building.

Root path: A geotextile channel connecting tree root balls to other adjacent trees and / or adjacent greenspace.

Shade tree: Large-scale deciduous tree, mature height above 30', generally having a single stem, planted primarily for shade.

Shrub: Small-scale plants, generally without a single stem, used as hedges, foundation planting, borders, and accents, possessing qualities such as flowers, fruit, and attractive foliage or shape.

Sidewalk planter: A raised planter located in the parkway landscape area.

Structural soil: Soil that has been amended with aggregate to support concrete sidewalks and asphalt parking lots while providing nourishment to plant roots (e.g. "Cornell," "Amsterdam," or other soil that has the ability to support a concrete slab while allowing for root penetration).

Tree grate: Cast iron covering over a tree pit allowing pedestrian circulation over the pit while reducing soil compaction.

Tree guard: Protective cage around a tree trunk, usually cast-iron, attached to a tree grate, to protect the tree trunk.

Tree pit: A cut-out or hole in the sidewalk, filled with soil, in which a tree is planted, sometimes covered with a tree grate.

Urban heat island: Developed area marked by an increase in ambient air temperatures due to large amounts of concrete, asphalt and metal absorbing and reflecting solar energy.

Vehicular use area: Any area of the lot not located within any enclosed or partially enclosed structure and which is devoted to a use by or for motor vehicles including parking (accessory or non-accessory) or storage of automobiles, trucks or other vehicles; loading areas; service areas and drives; and access drives and driveways.

Six blue-line or black-line prints of the landscape plan must be submitted. The plan must have a scale of 1" = 40'-0" or larger (e.g., 1" = 30'-0" or 1" = 20'-0") and be on standard size drawing sheets not to exceed 36 x 48 inches.

The Landscape Plan (required under section 11.5-1 of the Chicago Zoning Ordinance) must include the following information:

- Drawing scale
- Drawing orientation (indicated by conventional north arrow)
- Property lines, easements, and rights-of-way frontages, showing dimensions
- Sight triangles at intersections and at alley and driveway curb cuts
- Total vehicular use area calculation
- Location and dimensions of all landscaped areas including parkway planting; parking lot and vehicular use area screening; parking lot and vehicular use area internal planting
- Location, botanical name and sizes of all plants and the location of other pertinent landscape features
- Location of all existing trees on site greater than 2 1/2" caliper that the applicant proposes to remove
- Location of all existing trees on site greater than 2 1/2" caliper which are to be retained and counted towards the planting requirements
- Location of existing parkway trees including a description of their quality and species
- Location, design, height, and building material of all proposed walls, tree pits, planter containers, and fences
- Location of existing and proposed street lights and fire hydrants in public rights-of-way
- Size and location of all existing and proposed public and private utility improvements, both underground and overhead, within the public rights-of-way
- Proposed layout of vehicular use areas including the location and dimensions of parking spaces, islands, internal planting, pedestrian walkways, and driving aisles
- Direction of street traffic using one- or two-way arrows
- Estimated time scheduled for planting
- Names, addresses, and phone numbers of the owner and the registered landscape architect responsible for preparing the landscape plans
- A certified statement, signed by the owner(s), committing to the protection and, if necessary, replacement of all existing parkway trees and internal trees designated for credit toward landscaping requirements (See Appendix G)
- A certified statement, signed by the owner(s), committing to the maintenance of required landscaping (See Appendix G)
- A certified statement, signed by the registered landscape architect responsible for preparing the landscape plans, stating that the plans have been prepared in accordance with the zoning standards of the Chicago Zoning Ordinance, and the *Guide to the Chicago Landscape Ordinance* (See Appendix G)

Required information

Other submission requirements include:

- Plat of survey
- Survey showing existing trees (size, location, genus, and condition)
- Photographs of all existing trees with a caliper of two (2) inches or greater
- Plan of types and extent of soil modifications and drainage
- Results of test of existing soil
- Results of test of import soil
- Results of percolation test

This section describes general standards; tree planting standards; hedge planting standards; shrub planting standards; and groundcover planting standards.

General standards

To ensure installation of plants that will thrive under stressful urban conditions, certain species must be encouraged. The standards listed below will help prevent the planting of trees that become hazards, maintenance problems, or a scar on the landscape.

Quality

Plants shall meet the standards of "American Standard for Nursery Stock," ANSI Z60.1-latest edition, American Association of Nurserymen, which by reference is made a part of these guidelines. References to minima and maxima with respect to plant height and spread, rootball diameter and depth, etc., are from this publication.

Plants shall meet all requirements of federal, state, and local law with respect to plant type, labeling, nursery or plant inspection, disease, insect, and other pest infestation, and any other requirements.

Plants shall be high-quality nursery-grown stock.

Substandard "B-grade" or "Park grade" plants are not acceptable.

Field-collected plants are not acceptable, even if they have been subsequently planted in the ground in a nursery or planted in a container.

Plants shall have been grown in a climate zone similar to Chicago's, i.e., United States Department of Agriculture (most recent USDA zone hardiness map) zone 4 or 5 (zone 5 plants are generally hardy only near the warming influence of Lake Michigan). Plants from zone 6B or more, i.e., warmer climate zones, are not acceptable.

Plants shall be in a healthy, vigorous condition, free of dead or broken branches, scars that are not completely healed, frost cracks, disfiguring knots, broken or abraded bark, redundant leaders or branches, rubbing branches, or aberrations of any kind. Plants shall not have multiple leaders, unless this is the natural form; multi-stem trees are not acceptable for required planting in parkways.

Plants shall have full, even, well-developed branching and a dense, fibrous, and vigorous root system.

Digging and handling

Balled-and-burlapped (B&B) plants shall be dug with a firm rootball of natural earth, of a size in proportion to the plant's size, as measured by caliper, height, or spread.

Balled-and-burlapped plants shall be handled only by the rootball, not by the trunk or branches, as this may break or loosen the rootball and damage the root system.

Container plants shall have been established for a minimum of one full growing season in their containers before installation.

Container plants shall be handled only by the container, not by the stems or branches, as this may pull the plant out of the container and break or loosen the rootball and damage the root system.

Bare-root shrubs and groundcover plants are acceptable, if they are dug and installed at the appropriate season and handled in the appropriate manner.

Bare-root trees are not acceptable.

Plants shall be protected from drying-out during shipping with tarpaulins or other covering.

Plants shall be protected from drying-out after delivery by planting immediately; if this is not possible, the rootball shall be covered with peat moss or earth, and watered frequently to keep it moist until planting.

Do not handle, move, bind, tie or otherwise treat plants so as to damage the rootball, roots, trunk, or branches in any way.

Inspection

During construction, parkway trees will be inspected by the Department of Zoning and the Bureau of Forestry to confirm compliance with the landscape ordinance. If the trees fail to meet the requirements of the landscape ordinance, they must be replaced at the owner's expense. At the end of five (5) years, the Department of Zoning will notify the Bureau of Forestry at which time the Bureau will perform an acceptance inspection. If the project is approved, the Bureau will then assume responsibility for the trees in the public right-of-way.

If an applicant is planting more than twenty-five (25) parkway trees, the Bureau of Forestry requires that all tree tagging be done by a Bureau representative prior to digging. Applicants should ensure that the nurseryman supplying the trees and the landscape architect observing the planting are familiar with the Bureau's standards and specifications. At the applicant's request, the Bureau's staff will inspect trees at the nursery. In such cases, the applicant must pay all Bureau expenses for inspection including the cost of travel, lodging (if necessary), and a ten percent administrative overhead fee.

Tree planting standards

Trees shall be installed per Appendix D, "Tree planting in parkway," "Tree planting in narrow parkway," "Tree planting in parkway planter," "Tree planting in tree pit with grate," or "Tree planting in parking lot island."

Size

Standards for size are at time of installation.

Minimum size shall be 2-1/2" caliper, measured 6" above ground.

Trees shall have a clear trunk, free of branches, to a minimum height of 6'-0".

Trees shall be balled-and-burlapped (B&B), with no exceptions.

2-1/2" caliper trees shall be 12'-0" to 14'-0" height, with a maximum height of 16'-0".

2-1/2" caliper trees shall have a minimum 28" diameter x 18" depth rootball.

Recommended Species

The following deciduous tree species and varieties are recommended (no conifers or needle evergreens are acceptable). The selection of trees is subject to the review of the Bureau of Forestry for specific locations.

<u>Botanical name</u>	<u>Common name</u>
Acer platanoides 'Emerald Queen'	Emerald Queen norway maple
Acer saccharum	Sugar maple
A. saccharum 'Columnare'	Columnar sugar maple
A. saccharum 'Green Mountain'	Green Mountain sugar maple
A. saccharum 'Wright Brothers'	Wright Brothers sugar maple
Catalpa spp.	Catalpa species
Celtis occidentalis	Hackberry
C. occidentalis 'Prairie Pride'	Prairie Pride hackberry
Corylus colurna	Turkish filbert
Fraxinus americana	White ash
F. americana 'Autumn Applause'	Autumn Applause white ash
F. americana 'Autumn Purple'	Autumn Purple white ash
F. americana 'Rose Hill'	Rose Hill white ash
Fraxinus excelsior	European ash
Fraxinus quadrangulata	Blue ash
Fraxinus pennsylvanica	Green ash
F. pennsylvanica 'Newport'	Newport green ash
F. pennsylvanica 'Patmore'	Patmore green ash
F. pennsylvanica 'Summit'	Summit green ash
Ginkgo biloba (male only)	Ginkgo
G. biloba 'Autumn Gold'	Autumn Gold ginkgo
G. biloba 'Fairmount'	Fairmount ginkgo
G. biloba 'Lakeview'	Lakeview ginkgo
G. biloba 'Princeton Sentry'	Princeton Sentry ginkgo
Gleditsia triacanthos inermis	Thornless honeylocust

Plant types and standards

<u>Botanical name</u>	<u>Common name</u>
<i>Gleditsia triacanthos inermis</i> 'Greenglory'	Greenglory honeylocust
<i>G. triacanthos inermis</i> 'Halka'	Halka honeylocust
<i>G. triacanthos inermis</i> 'Shademaster'	Shademaster honeylocust
<i>G. triacanthos inermis</i> 'Skyline'	Skyline honeylocust
<i>Gymnocladus dioicus</i>	Kentucky coffeetree
<i>Liriodendron tulipifera</i>	Tulip tree, yellow poplar
<i>Phellodendron amurense</i>	Amur corktree
<i>Pyrus calleryana</i> 'Chanticleer' **	Chanticleer flowering pear
<i>P. calleryana</i> 'Redspire' **	Redspire flowering pear
<i>P. calleryana</i> 'Whitehouse' **	Whitehouse floweringpear
<i>Quercus bicolor</i>	Swamp white oak
<i>Quercus imbricaria</i> **	Shingle oak
<i>Quercus muehlenbergii</i> **	Chinkapin oak
<i>Quercus robur</i> **	English oak
<i>Quercus rubrum</i> **	Red oak
<i>Quercus macrocarpa</i> **	Bur oak
<i>Tilia americana</i>	American linden
<i>T. americana</i> 'Fastigiata'	Pyramidal American linden
<i>T. americana</i> 'Redmond'	Redmond linden
<i>Tilia cordata</i>	Littleleaf linden
<i>T. cordata</i> 'Chancellor'	Chancellor linden
<i>T. cordata</i> 'Glenleven'	Glenleven linden
<i>T. cordata</i> 'Olympic'	Olympic linden
<i>Tilia x euchlora</i>	Redmond linden
<i>Tilia platyphyllos</i>	Big-leaf linden
<i>Tilia tomentosa</i>	Silver linden
<i>T. tomentosa</i> 'Sterling Silver'	Sterling Silver silver linden
<i>Tilia vulgaris</i>	European linden
<i>Ulmus carpinifolia</i> 'Accolade'	Accolade smoothleaf elm
<i>U. carpinifolia</i> 'Homestead'	Homestead smoothleaf elm
<i>U. carpinifolia</i> 'Regal'	Regal smoothleaf elm
<i>Zelkova serrata</i>	Zelkova
<i>Z. serrata</i> 'Greenvase'	Greenvase zelkova

* For use only in narrow parkways with nearby buildings and street

** Spring dig only

The specification of improved varieties of plants is recommended. The varieties of a given species may have a straighter trunk, a more symmetrical crown, better flowering or Fall color, resistance to disease or insect infestations, etc. All trees shall be wrapped with burlap from base to lowest branches and secured with biodegradable twine. Project owners are advised to seek advice when selecting plants: a certified nurseryman, the Cooperative Extension Service of the University of Illinois, a registered landscape architect, a reputable landscape contractor, etc.

Acceptable species, subject to approval

The following tree species and varieties are acceptable if specifically approved by the Bureau of Forestry:

<u>Botanical name</u>	<u>Common name</u>
Acer rubrum	Red maple
Acer saccharinum	Silver maple
Alnus glutinosa	Alder
Betula nigra	River birch
Malus spp.	Apples, crabapples
Metasequoia glyptostroboides	Dawn redwood
Populus spp.	Poplars, cottonwood, aspen
Prunus spp.	Cherries, plums
Robinia pseudoacacia	Black locust
Taxodium distichum	Bald cypress

Unacceptable species

The following tree species and varieties are unacceptable (conifers or needle evergreens are unacceptable; trees with thorns are unacceptable for any parkway planting):

<u>Botanical name</u>	<u>Common name</u>
Acer negundo	Box elder
Ailanthus altissima	Tree-of-heaven
Elaeagnus angustifolia	Russian olive
Ginkgo biloba (female)	Female ginkgo
Maclura pomifera	Osage orange
Salix spp.	Willows

Other species

Planting of any tree species or varieties not listed above as an acceptable species will require application to, and permission from, the Bureau of Forestry.

Unacceptable forms

The following tree forms are unacceptable for parkway planting:

Multi-stem: trees with two or more trunks

Espalier or topiary: geometrical plant forms achieved through pruning which are contrary to natural form

Dwarf or small-scale: those trees which grow higher than 3'-0" but cannot be undertrimmed to a minimum height of 6'-0"

Topped or dehorned: trees with most of the crown removed, such that the main branches end abruptly in stubs

Hedge planting standards

Hedge plants shall be installed per Appendix D, "Shrub Planting".

Size

Size standards are at time of installation.

Minimum height of hedge plants shall be 30".

Minimum spread of hedge plants shall be 24".

Narrow, upright, or smaller plants, such as Japanese barberry, Peking cotoneaster, Compact burning bush, Hick's Yew, Compact European cranberry, and Compact American cranberry may be difficult to obtain with a 24" spread, and shall have a minimum 18" spread.

Spacing

Spacing standards are at time of installation.

Maximum spacing of hedge plants shall be 36".

Narrow, upright, or smaller plants, such as Japanese barberry, Peking cotoneaster, compact burning bush, Hicks yew, Compact European cranberry, and Compact American cranberry make a more effective screen when planted closer together, and shall have a maximum 30" spacing.

Hedge maintenance

Hedge height shall be maintained per Section III.B, Vehicular Use Area Screening Requirements:

Type A vehicular use area screening (street frontage): from 2'-6" to 4'-0" height

Type B vehicular use area screening (side or rear lot lines): from 5'-0" to 7'-0"

Hedges shall be maintained as dense, continuous lines of foliage, and shall not be sheared as a series of individual plants.

Hedges shall be sheared with "battered" sides, i.e., the base wider than the top, to allow light to reach the lower part of the plant, to prevent the foliage at the bottom from thinning.

Recommended Species

The following shrub species and varieties are recommended:

<u>Botanical name</u>	<u>Common name</u>
<i>Aronia melanocarpa</i>	Black chokeberry
<i>Berberis thunbergii</i>	Japanese barberry
<i>Buxus microphylla koreana</i>	Korean boxwood
<i>Caragana arborescens</i>	Siberian peashrub
<i>Corylus americana</i>	American filbert
<i>Cotoneaster apiculata</i>	Cranberry cotoneaster
<i>Cotoneaster horizontalis</i>	Rockspray cotoneaster
<i>Euonymus fortunei</i> 'Sarcxie'	Sarcxie wintercreeper
<i>Forsythia</i> 'Arnold Dwarf'	Arnold dwarf forsythia
<i>F. viridissima</i> 'Bronxensis'	Bronx greenstem forsythia
<i>F. x intermedia</i>	Border forsythia
<i>Ilex x meserveae</i>	Blue holly
<i>Juniperus chinensis</i>	Chinese junipers
<i>Juniperus chinensis procumbens</i>	Japanese garden juniper
<i>Juniperus horizontalis</i>	Dwarf creeping junipers
<i>Ligustrum vulgare</i>	Common privet
<i>Ligustrum x vicaryi</i>	Golden vicary privet
<i>Potentilla fruticosa</i>	Potentilla
<i>Rhus aromatica</i> 'Gro-low'	Gro-low sumac
<i>Ribes alpinum</i>	Alpine currant
<i>Spiraea japonica</i>	Japanese spirea
<i>Spiraea x bumalda</i>	Bumalda spirea
<i>Syringa meyeri</i>	Meyer's lilac
<i>Syringa patula</i> 'Miss Kim'	Miss Kim Korean lilac
<i>Taxus cuspidata</i>	Japanese yew
<i>Taxus x media</i> 'Tauntonii'	Taunton yew
<i>Viburnum carlesii</i> 'Compacta'	Dwarf Koreanspice viburnum
<i>Viburnum trilobum</i> 'Compactum'	Compact American cranberry
<i>Viburnum trilobum</i> 'Hahs'	Hahs American cranberry
<i>Viburnum x caricephalum</i>	Fragrant viburnum

Other Species

Planting of any species or varieties not listed above will require application to, and permission from, the Bureau of Forestry.

Groundcover planting standards

Groundcover shall be installed per Appendix D, "Shrub planting".

Groundcover planting is not required, except in required vehicular use area internal planting. However, it is encouraged in appropriate locations as an adjunct to required internal planting.

General

For safety and visibility, groundcovers can be planted only in certain areas of the parkway.

Groundcover plants are subject to the following restrictions:

Shall be maintained below 3'-0" height; because of the nature of the plants, this should not be a problem.

Locate such that traffic signals are visible for a minimum distance of 250'-0" as measured from the stop line, sighted from the traffic lane closest to the curb.

Recommended Species

The following groundcover species and varieties are recommended:

<u>Botanical name</u>	<u>Common name</u>
<i>Aegopodium podagraria</i>	Goutweed
<i>Cotoneaster adpressa</i>	Creeping cotoneaster
<i>Cotoneaster dammeri</i>	Bearberry cotoneaster
<i>Cotoneaster horizontalis</i>	Rock spray cotoneaster
<i>Cotoneaster horizontalis 'Hesse'</i>	Hesse cotoneaster
<i>Euonymus fortunei 'Colorata'</i>	Purpleleaf wintercreeper
<i>Euonymus fortunei vegetus</i>	Bigleaf wintercreeper
<i>Hedera helix</i>	English ivy
<i>Juniperus chinensis procumbens</i>	Japanese garden juniper
<i>Juniperus chinensis sargentii</i>	Sargent juniper
<i>Juniperus conferta</i>	Shore juniper
<i>Juniperus horizontalis</i>	Creeping juniper
<i>Lonicera henry</i>	Henry honeysuckle
<i>Pachysandra terminalis</i>	Japanese pachysandra
<i>Rhus aromatica 'Gro-low'</i>	Gro-low sumac
<i>Vinca minor</i>	Periwinkle

Certain species listed above require a more sheltered planting environment and project owners are advised to seek advice when selecting plants: a certified nurseryman, the Cooperative Extension Service of the University of Illinois, a registered landscape architect, a reputable landscape contractor, etc.

Other Species

Planting of any species or varieties not listed above will require application to, and permission from, the Zoning Administrator and the Bureau of Forestry.

Plant types and standards

Host trees:

Not approved for use in Asian longhorn beetle quarantine areas

<u>Species</u>	<u>Including, but not limited to:</u>
Acer spp.	Norway maple Sugar maple Silver maple Boxelder
Aesculus spp.	Horse chestnut
Betula spp.	River birch European birch Grey birch
Citrus spp.	Orange and lemon
Fraxinus spp.	All ash
Hibiscus spp.	Shrub althea, Rose-of-Sharon
Melia	Chinaberry
Malus spp.	All crabapple
Morus spp.	All mulberry
Platanus spp.	All planetree
Populus spp.	All poplar
Prunus spp.	All cherry, peach, plum, apricot, almond
Pyrus spp.	All pear
Robinia spp.	Black locust
Salix spp.	All willow
Ulmus spp.	All elm

Non - host street trees:

Approved for use in Asian longhorn beetle quarantine areas in public right-of-way

<u>Botanical name</u>	<u>Common name</u>
Gymnocladus dioicus	Kentucky coffeetree
Carpinus spp.	Hornbeam
Ginkgo biloba	Maidenhair tree
Cercis canadensis (tree form)	Eastern redbud
Metasequoia glyptostroboides	Dawn redwood
Ailanthus altissima	Tree of heaven
Crataegus spp.(tree form)	Hawthorns
Gleditsia triacanthos var. inermis spp.	Seedless, thornless honeylocust
Tilia spp.	Linden
Amelanchier spp. (tree form)	Serviceberry
Catalpa spp.	Catalpa
Celtis spp.	Hackberry
Liriodendron tulipifera	Tulip tree
Syringa spp. (tree form)	Lilacs
Corylus colurna	Turkish filbert
Ostrya virginiana (tree form)	Ironwood
Quercus spp.	Oak
Taxodium distichum	Bald Cypress
Cercidiphyllum japonica	Katsuratree
Sorbus spp.	Mountain ash
Liquidambar styraciflua	Sweetgum
Phellodendron amurense	Corktree
Cornus spp.(tree form)	Dogwood
Corylus avellana	European filbert
Carya spp.	Hickory and pecan

Revised 12/21/98

Plant types and standards

Non - host trees:

Approved for use in non - parkway Asian longhorn beetle quarantine areas

<u>Botanical name</u>	<u>Common name</u>
Gymnocladus dioicus	Kentucky coffeetree
Carpinus spp.	Hornbeam
Ginkgo biloba	Maidenhair tree
Cercis canadensis	Eastern redbud
Metasequoia glyptostroboides	Dawn redwood
Ailanthus altissima	Tree of heaven
Crataegus spp.	Hawthorn
Gleditsia triacanthos var. Inermis spp.	Seedless, thornless honeylocust
Tilia spp.	Linden
Amelanchier spp.	Serviceberry
Catalpa spp.	Catalpa
Celtis spp.	Hackberry
Liriodendron tulipifera	Tulip tree
Syringa spp.	Lilac
Corylus colurna	Turkish filbert
Ostrya virginiana	Ironwood
Quercus spp.	Oak
Taxodium distichum	Bald cypress
Cercidiphyllum japonica	Katsuratree
Sorbus spp.	Mountain ash
Liquidambar styraciflua	Sweetgum
Phellodendron amurense	Corktree
Cornus spp.	Dogwood
Corylus avellana	European filbert
Carya spp.	Hickory and pecan
Juniperus spp.	Juniper
Larix spp.	Larch
Pinus spp.	Pine
Picea spp.	Spruce
Pseudotsuga menszii	Douglas fir
Tsuga spp.	Hemlock
Fagus spp.	Beech
Ilex spp.	Holly
Diospyros virginiana	Common persimmon
Thuja spp.	Arborvitae
Juglans nigra	Black walnut
Rhus spp.	Sumac

Revised 12/21/98

The following planting details are intended to serve as guides to the correct design and installation of plants. They show the relationships of materials and concepts defined elsewhere in this Guide. They are not drawn to a particular scale. Final plans, as prepared by a registered landscape architect, will need to incorporate additional, site-specific details such as drainage and irrigation. Other items concerning the culture and maintenance of plants (i.e. pruning and maintaining a hedge) will need to be addressed by a separate landscape maintenance manual prepared by the landscape architect.

Please note the deletion of tree staking, guying, and trunk wrapping which were shown in the previous edition of this Guide. Subsequent research and industry practices have shown that such standards may actually do more harm to the long-term viability of a tree than not using them at all. (Guying may still be advisable under extremely windy conditions.) Trees should have their north side marked at the nursery and should be planted with the same orientation at the new site. This will provide for the same resistance to splitting that wrapping provided, while not incurring the negative effects of wrapping such as trapping insects and moisture in contact with the tree. The details submitted as a part of the landscape plan should reflect these changes.

Additional information regarding the correct planting details for trees and shrubs can be obtained from the International Society of Arboriculture, 1400 West Anthony Drive, Champaign, IL 61821 (217) 355-9411.

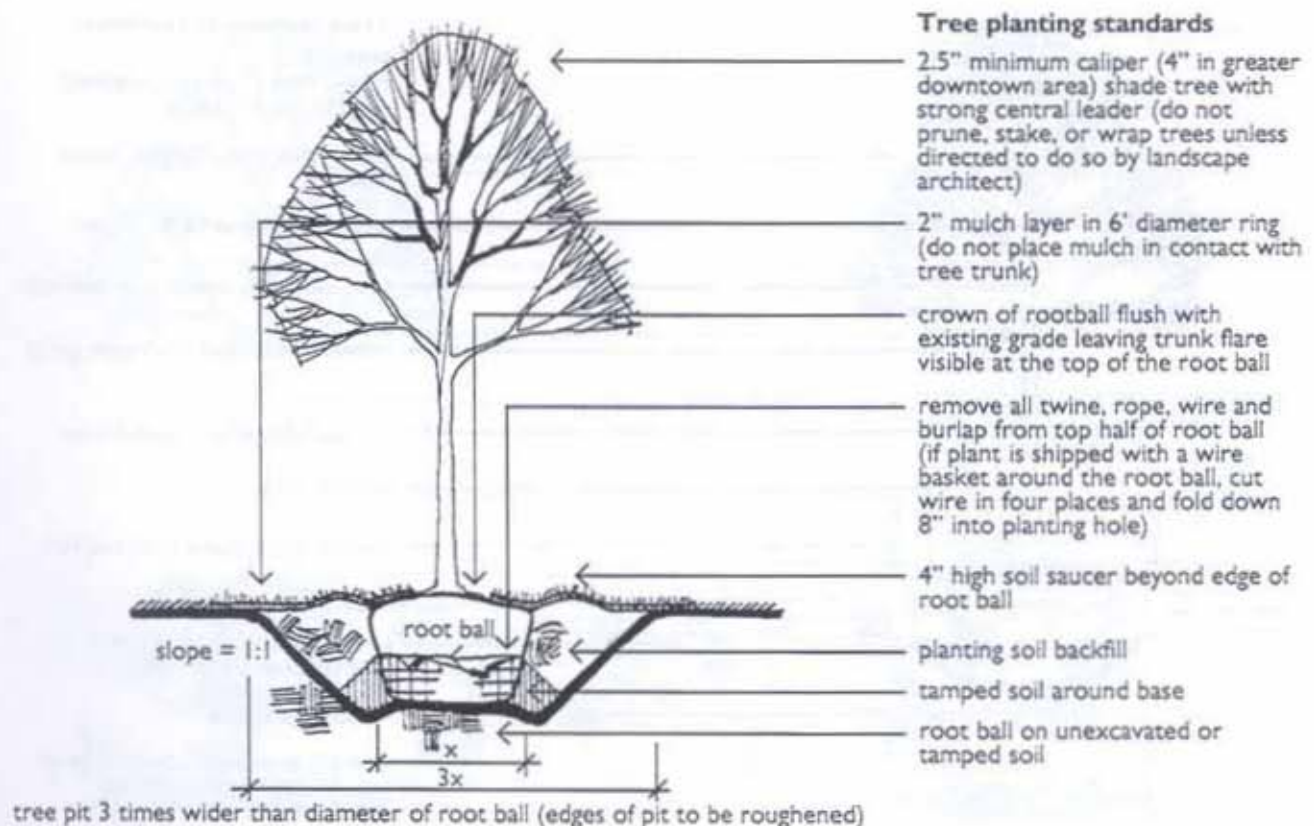

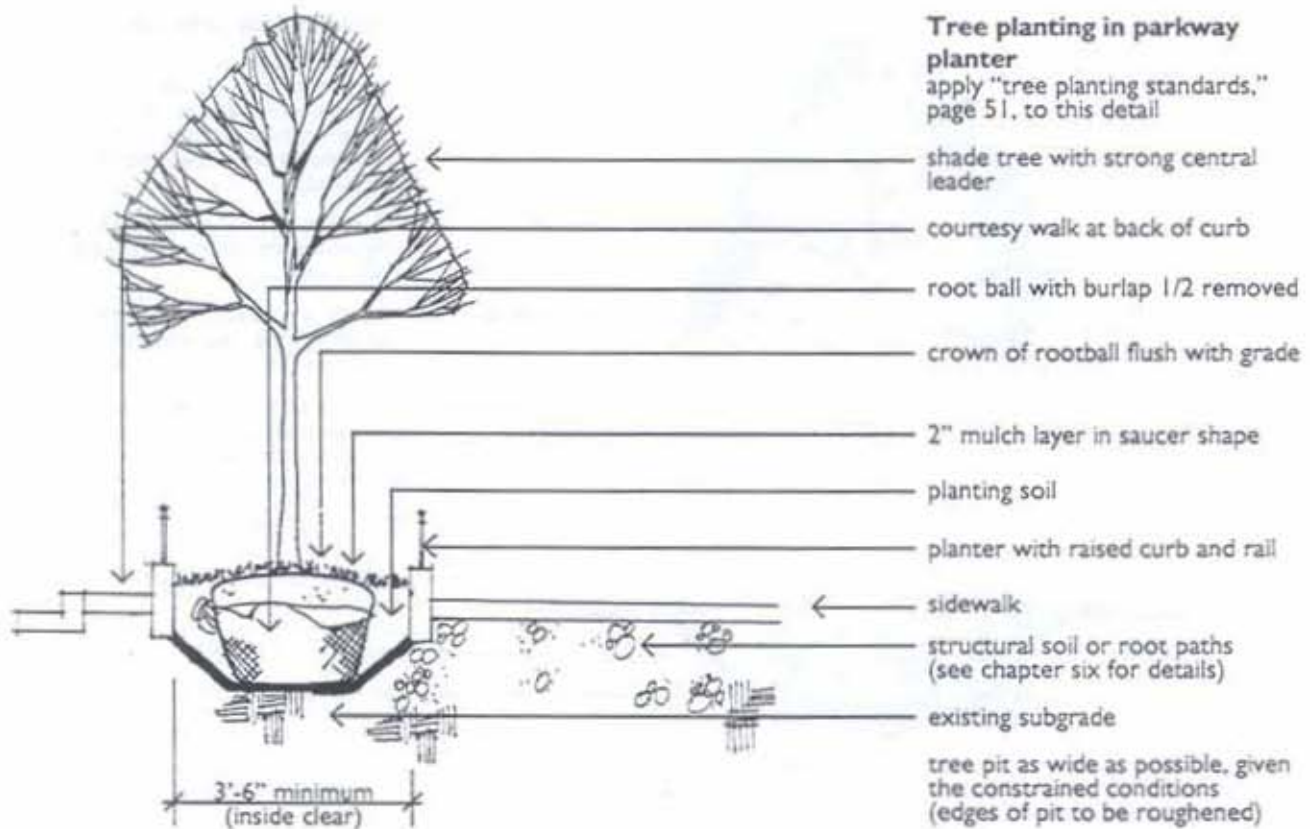
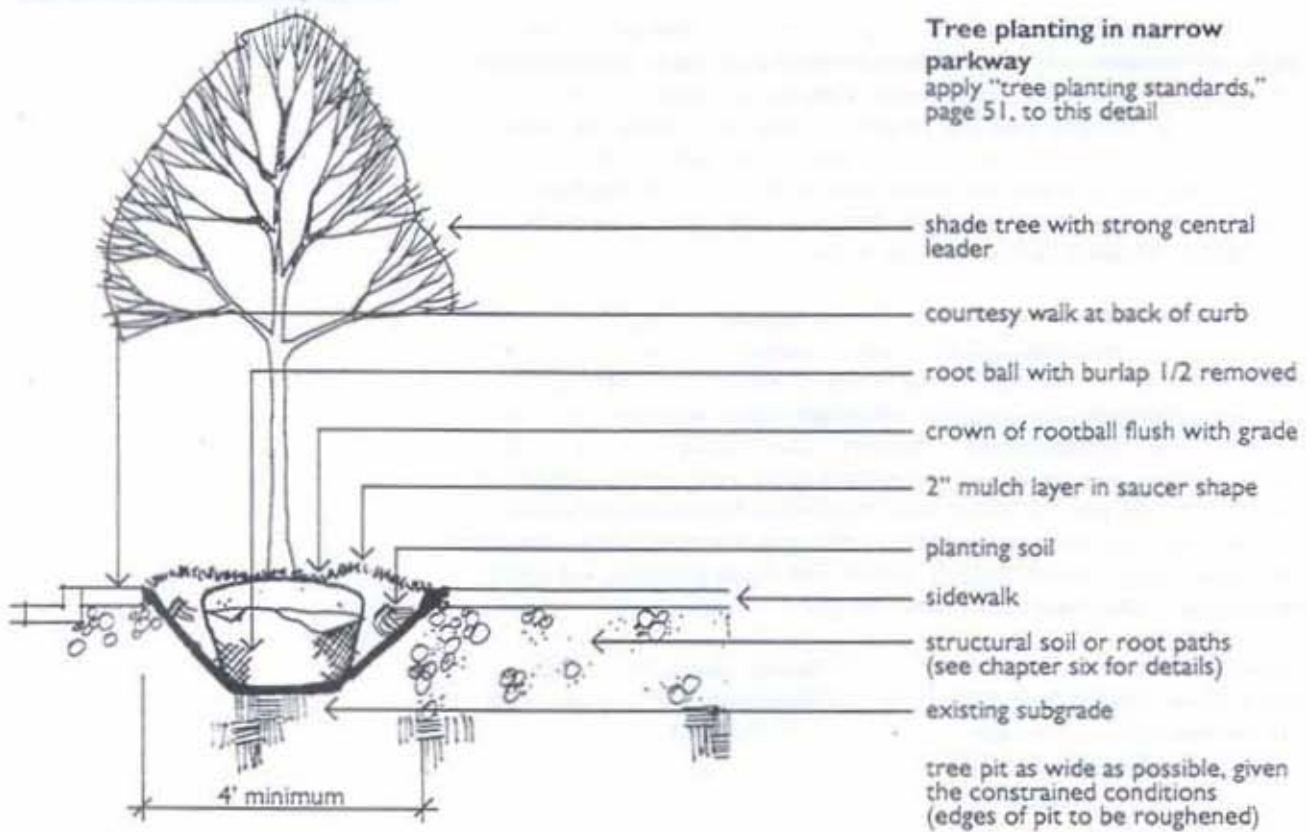

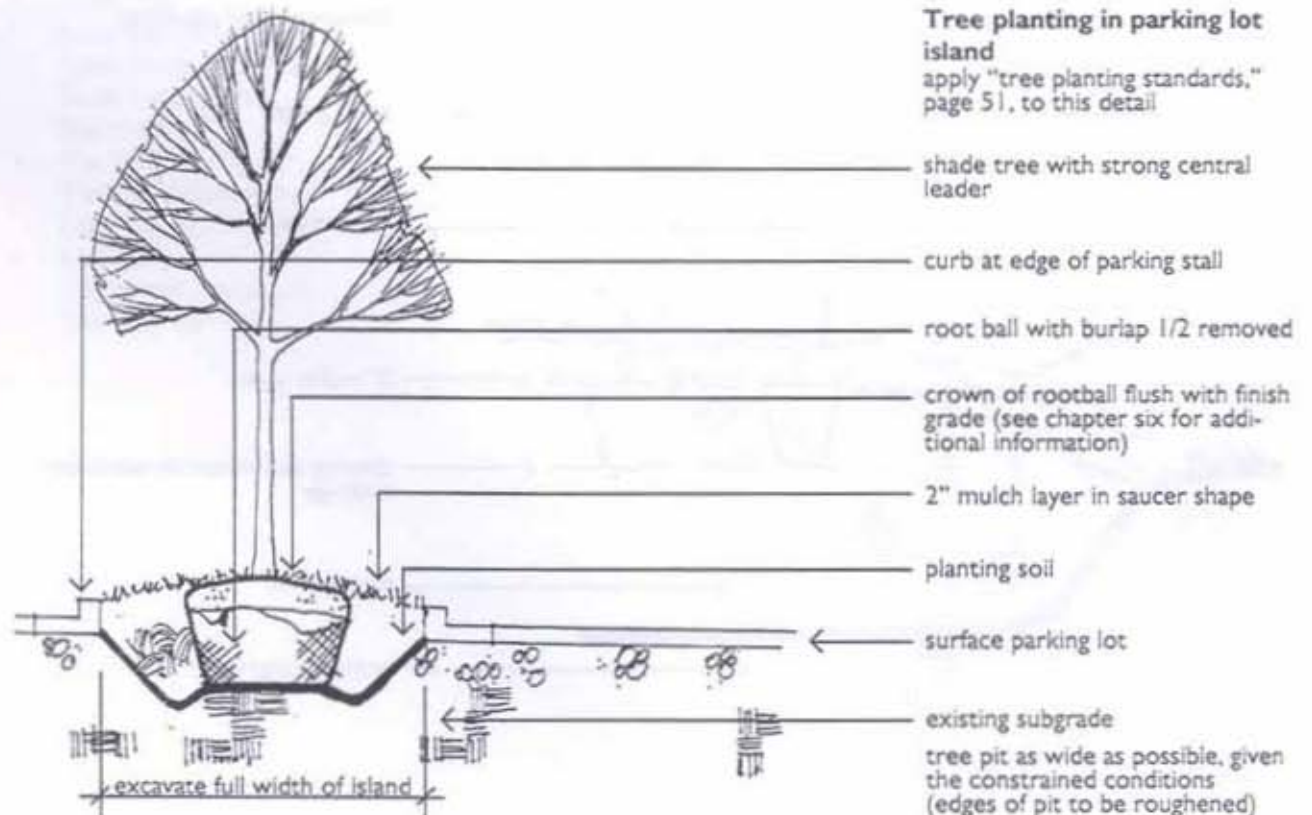
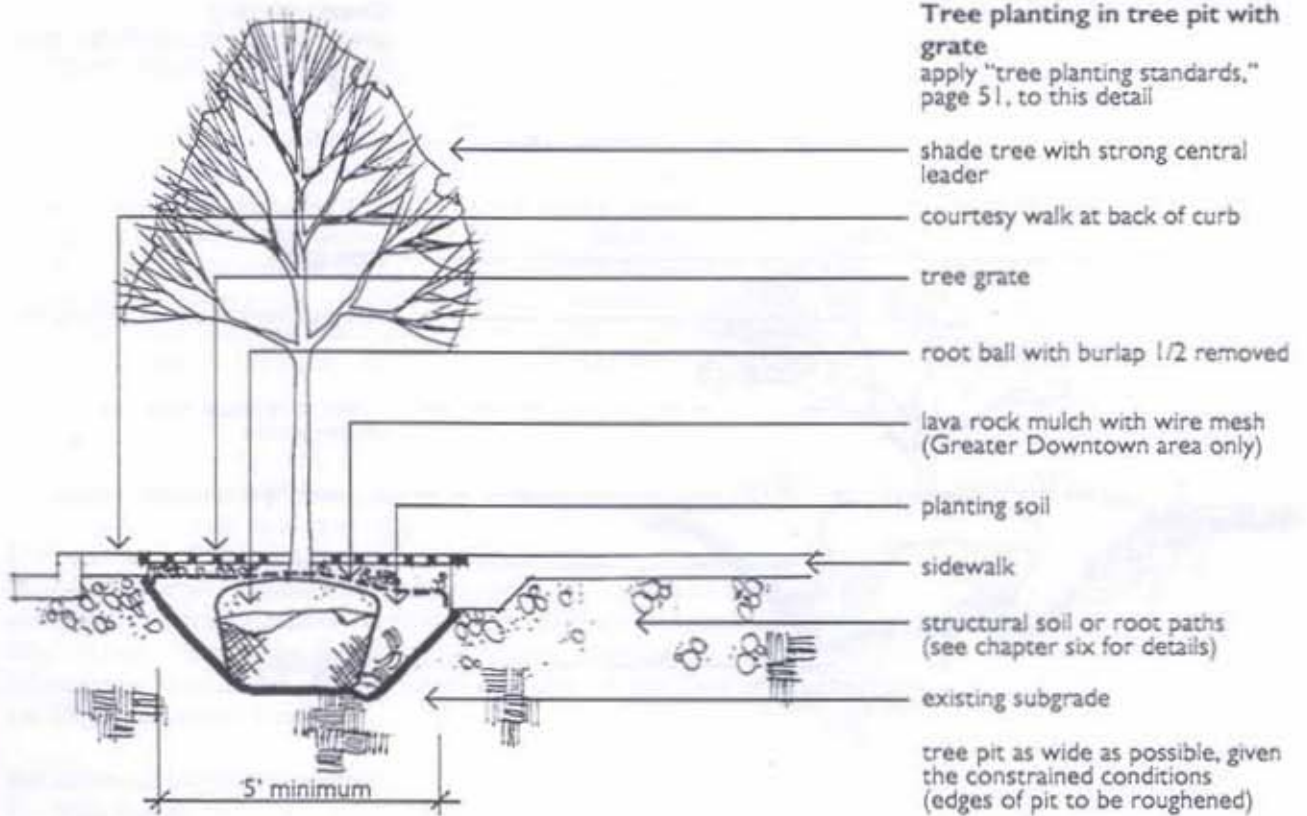

Planting details

Shrub planting

see "tree planting standards," page 51 for additional similar requirements

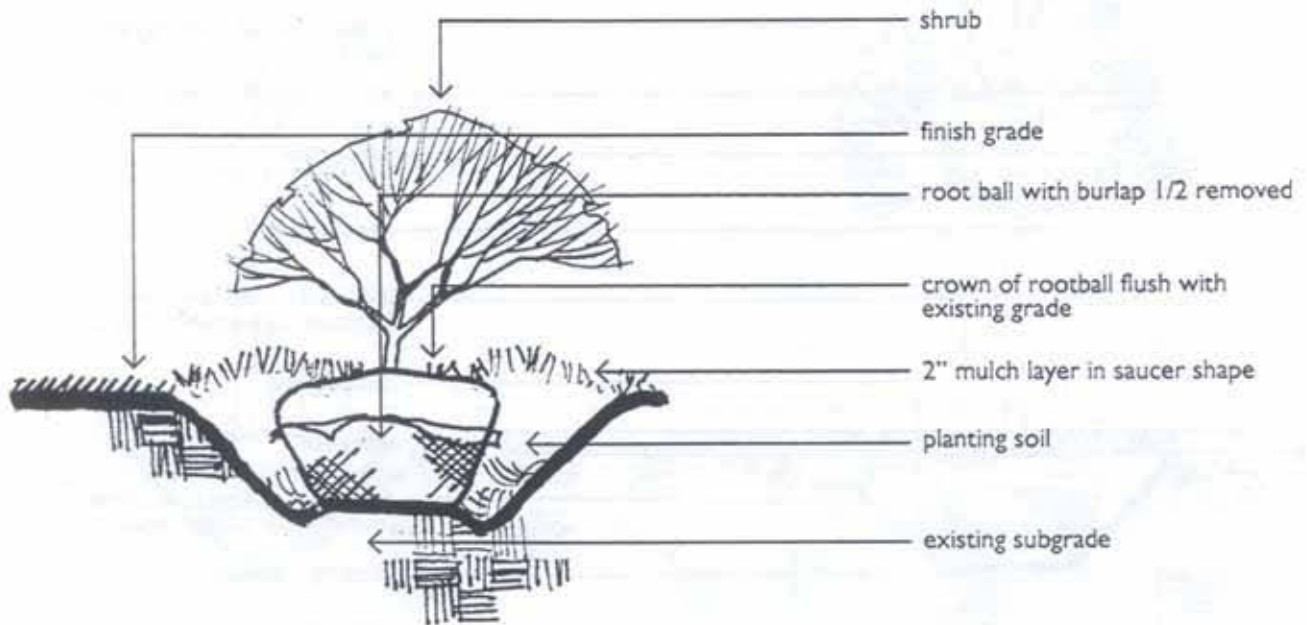

Groundcover planting

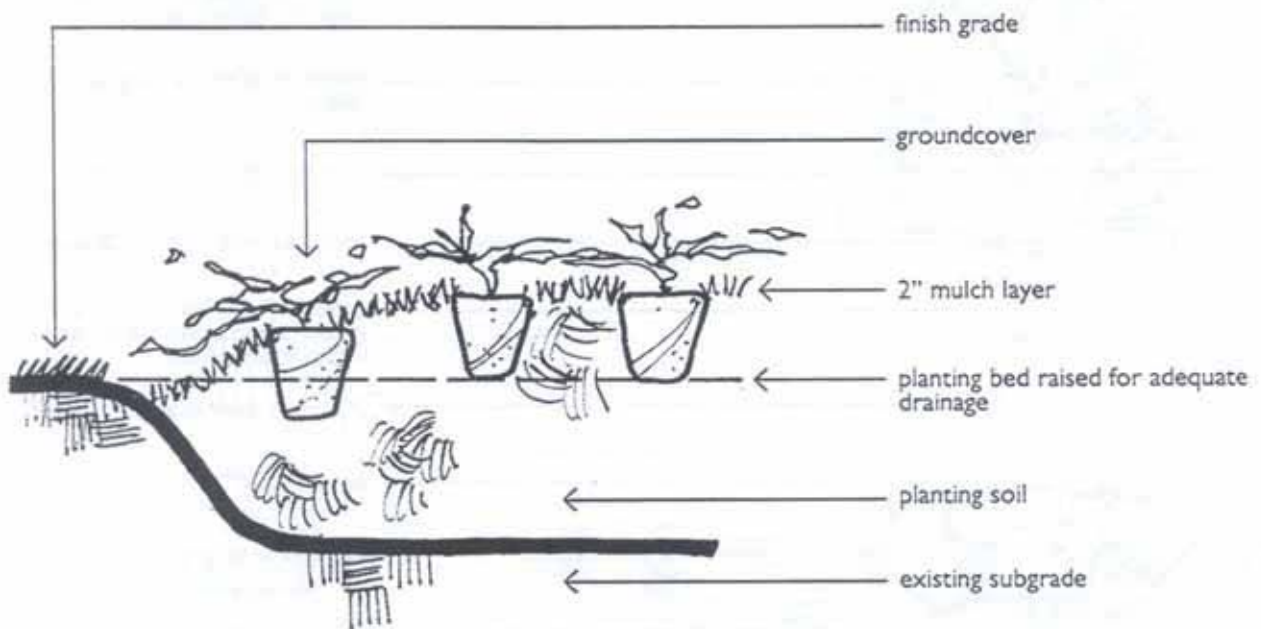

"Structural soil" is a growing medium designed to provide room for the development and growth of plant roots while meeting or exceeding pavement foundation requirements. It was developed by Cornell University as a mix of gap-graded gravels in conformance with the Unified Soil Classification system with a minimum California Bearing Ratio exceeding 50 when properly compacted. Structural soil is comprised of crushed stone (not limestone), clay loam and a hydro-gel stabilizer. The intent is to form a two part system: a rigid, high bearing capacity stone structure and a viable rooting zone for planted material suspended within the voids of the stone structure. This is achieved by mixing an angular stone of known size and shape with a soil predominately passing a #200 sieve. The object is to minimize or eliminate all size fractions between 0.75 inches and medium sand (0.16 inches) as defined by the USDA soil classification system.

The result is a soil system that is designed to encourage continuous, interconnected root masses rather than isolated roots in individual tree pits. This will lead to healthier trees while providing a sound base for paving materials. Structural soil will function as a sub-base material under pavements for pedestrian traffic or light vehicular traffic with the ability to withstand loading of emergency and/or maintenance vehicles. Its intended purpose is for establishing trees in areas where the tree is totally surrounded by pavement and space limitations or other factors preclude the use of non-paved tree zones or large tree planting containerized areas.

For additional information, contact the following individuals or organizations:

- Nina Bassuk, Director
Urban Horticulture Institute
Cornell University
Ithaca, NY
- Jason Grabosky
Urban Horticulture Institute
Cornell University
Ithaca, NY
- Gary Watson
The Morton Arboretum
Lisle, Illinois
- Pat Kelsey
The Morton Arboretum
Lisle, Illinois

The following is a recommended calendar for the care of newly installed plants.

January

- Remove any litter found within turf and landscaped areas
- Check for and remove any debris caught in trees and shrubs
- Check and maintain all winter coverings, including evergreen boughs and holiday lighting
- Prune any damaged tree branches as needed

February

- Remove any litter found within turf and landscaped areas
- Check for and remove any debris caught in trees and shrubs
- Remove all winter coverings, including evergreen boughs, and holiday lighting
- Check perennial plantings and reset those plants that have been heaved from the ground due to frost
- Inspect all trees, shrubs (including roses), and vines to determine pruning needs and complete this work prior to bud break

March

- Remove any litter found within turf and landscaped areas
- Check for and remove any debris caught in trees and shrubs
- Remove all winter coverings, including evergreen boughs, and holiday lighting
- Check perennial plantings and reset those plants that have been heaved from the ground due to frost
- Inspect all trees, shrubs (including roses), and vines to determine pruning needs and complete this work prior to bud break

April

- Remove any litter found within turf and landscaped areas
- Check for and remove any debris caught in trees and shrubs
- Perform spring bed clean-up in all locations prior to any required division of perennials
- Trim back all perennials not previously cut back
- Water semi-irrigated and non-irrigated landscaped areas as required
- Mulch planting areas
- Begin monitoring for pest and disease problems
- Begin mowing lawn areas
- Monitor all planting beds for weedy conditions and take appropriate measures to maintain all plantings in a weed-free condition

Landscape maintenance schedule

May

- Remove any litter found within turf and landscaped areas
- Check for and remove any debris caught in trees and shrubs
- Complete required perennial division and transplant activities
- Braid or remove 25% of green foliage from spring blooming bulbs
- Trim back all perennials as required
- Water landscaped areas as needed
- Mulch planting areas
- Continue monitoring for pest and disease problems
- Monitor all planting beds for weedy conditions and take appropriate measures to maintain all plantings in a weed-free condition

June

- Remove any litter found within turf and landscaped areas
- Check for and remove any debris caught in trees and shrubs
- Monitor newly installed plantings for watering requirements
- Monitor all planting beds for weedy conditions and take appropriate measures to maintain all plantings in a weed-free condition
- Monitor all landscaped areas for pest and disease problems
- Mulch planting areas as needed
- Prune all shrubs and hedges (following blooming period if appropriate)

July

- Remove any litter found within turf and landscaped areas
- Check for and remove any debris caught in trees and shrubs
- Continue to monitor plantings installed this season for watering needs
- Monitor all planting beds for weedy conditions and take appropriate measures to maintain all plantings in a weed-free condition
- Monitor all landscaped areas for pest and disease problems
- Monitor mulch depth and adjust as needed

August

- Remove any litter found within turf and landscaped areas
- Check for and remove any debris caught in trees and shrubs
- Begin any required deadheading, dead leafing, pruning, and pinching of perennials and annuals
- Monitor all planting beds for weedy conditions and take appropriate measures to maintain all areas in a weed free condition
- Monitor mulch depths and adjust as needed
- Order spring blooming bulbs for fall installation
- Monitor all landscaped areas for pest and disease problems

September

- Remove any litter found within turf and landscaped areas
- Check for and remove any debris caught in trees and shrubs
- Continue any required deadheading, dead leafing, pruning, and pinching of perennials and annuals
- Monitor all planting beds for weedy conditions and take appropriate measures to maintain all areas in a weed free condition
- Continue to monitor mulch depths as needed
- Survey all planting areas specified and note and dead, damaged or missing plants and begin installing new plant material
- Prune shrubs and hedges for the last time this month

October

- Remove any litter found within turf and landscaped areas
- Check for and remove any debris caught in trees and shrubs
- Begin fall clean-up of planting beds
- Do not cut back perennials until they go dormant
- Annuals may be removed at this time
- Monitor all planting beds for weedy conditions and take appropriate measures to maintain all areas in a weed free condition
- Continue to monitor mulch depths and adjust as needed
- Complete installation of new plant material by the middle of this month
- Begin installing spring blooming bulbs
- Install and maintain holiday decorations as desired

November

- Remove any litter found within turf and landscaped areas
- Check for and remove any debris caught in trees and shrubs
- Complete installation of spring blooming bulbs
- Begin performing any necessary tree pruning maintenance once the trees are dormant
- Complete fall bed clean-up this month
- Perennial foliage shall not be cut back until plants go dormant
- Mulch planting areas
- Install winter evergreen covers
- Maintain all winter coverings, including evergreen boughs
- Maintain all lighting in operating order, including all seasonal lighting

December

- Remove any litter found within turf and landscaped areas
- Check for and remove any debris caught in trees and shrubs
- Maintain all winter coverings, including evergreen boughs
- Maintain all lighting in operating order, including all seasonal lighting

The following certified statements are to be signed by the appropriate parties and made a part of each landscape plan.

Sworn statement by owner

Commits to the maintenance of required landscaping in the following form:

"The undersigned acknowledges that the landscape planting plan shown on the attached landscape plan(s) for the property at _____ (street address), Chicago, Illinois (zip code) has, to the best of the undersigned applicant's knowledge, been designed and will be installed, maintained, and replaced as required, by current and subsequent owners in accordance with the requirements of Title 10, Chapter 32 of the Chicago Municipal Code, the landscaping standards of the Chicago Zoning Ordinance, and the *Guide to the Chicago Landscape Ordinance*."

Sworn statement by owner

Commits to the protection and replacement of required landscaping in the following form:

"Existing parkway and on-site interior trees are to be protected while project is under construction and will be replaced by current and subsequent owner if damaged."

Sworn statement by registered landscape architect

Commits to the preparation of the landscape plan in the following form:

"The undersigned landscape architect, registered in the State of Illinois, acknowledges that the landscape planting plan and construction details shown on the attached landscape plan(s) for the property at _____ (street address), Chicago, Illinois _____ (zip code) has been designed in accordance with the requirements of Title 10, Chapter 32 of the Chicago Municipal Code, the landscaping standards of the Chicago Zoning Ordinance, and the *Guide to the Chicago Landscape Ordinance*."

The City of Chicago wants to encourage its citizens to help enforce the landscape ordinance. By requiring the following notices to be posted at a job site, neighbors and interested people can verify if the approved plans are being implemented. Projects that are suspected to not be in compliance can be reported for follow-up to the Department of Zoning.

The following are to be put on display on site at the same time as the building permit:

- A copy of the approved landscape plan
 - No smaller than 11" x 17"
 - Laminated to protect the plan
 - Showing all plant types, sizes, and locations

- An instructional sign
 - No smaller than 8-1/2" x 11"
 - Laminated to protect the sign
 - Stating the following:

"If you see any problems with this landscape plan or the construction of it, please call the City of Chicago, Department of Zoning at 312.744.9445"

The City of Chicago wants to encourage its citizens to help enforce the landscape ordinance. By requiring the following notices to be posted at a job site, neighbors and interested people can verify if the approved plans are being maintained as approved. Projects that are suspected to not be in compliance can be reported for follow-up to the Department of Zoning.

The following are to be put on display on site at the same time as the building permit:

- A copy of the approved landscape plan
 - No smaller than 11" x 17"
 - Laminated to protect the plan
 - Showing all plant types, sizes, and locations

- An instructional sign
 - No smaller than 11" x 17"
 - Laminated to protect the sign
 - Stating the following:

"The owner of this site has agreed to install and maintain the required landscaping on this site in accordance with the Chicago Landscape Ordinance. Compliance requires the following:

- New trees and shrubs will be watered for the first two years until firmly established
- New trees and shrubs will be pruned to remove dead or damaged wood
- Mulch in planting beds will be maintained at a depth of 3"
- All planting beds and tree mulch circles will be weeded regularly
- Perennials and herbaceous shrubs will be pruned before the onset of new spring growth
- All grass will be mowed regularly (i.e. once per week) during the growing season

If you see any problems with the landscaping of this site or the maintenance of it, please call the City of Chicago, Department of Zoning at 312.744.9445"