



City of Chicago



O2022-3368

Office of the City Clerk

Document Tracking Sheet

Meeting Date: 10/26/2022

Sponsor(s): Misc. Transmittal

Type: Ordinance

Title: Zoning Reclassification Map No. 1-E at 201-221 E Erie St,
631-649 N St. Clair St and 200-212 E Ontario St - App No.
21177

Committee(s) Assignment: Committee on Zoning, Landmarks and Building Standards

21177
INTRO DATE
OCT. 26, 2022

ORDINANCE

Be It Ordained by the City Council of the City of Chicago:

SECTION 1. That the Chicago Zoning Ordinance be amended by changing all the Business Planned Development Number 468 symbols and indications as shown on Map Number 1-E in the area bounded by:

East Erie Street; the north/south public alley 212.00 feet east of North St. Clair Street; the east/west public alley next south of and parallel to East Erie Street; a line 118.50 feet east of North St. Clair Street; East Ontario Street; and North St. Clair Street (legal description attached hereto),

to the designation of Business Planned Development Number 468, as amended, which is hereby established in the area above described, subject to such use and bulk regulations as are set forth in the Plan of Development herewith attached and made a part thereof and to no others.

SECTION 2. This ordinance shall be in force and effect from and after its passage and due publication.

Legal Description and Plan of Development Statements referred to in this ordinance read as follows:

Legal Description Of The Property Located At 633 North St. Clair Street.

Parcel 1:

All of Lots 1, 2, 3, 4, 5, 6, 7, 8 and 27, together with Lot 26 (except the east 18 feet thereof) in the subdivision of the west 394 feet (except the east 14 feet of the north 80 feet thereof) in Block 32 in Kinzie's Addition to Chicago in the east half of the northwest quarter of Section 10, Township 39 North, Range 14 East of the Third Principal Meridian, all in Cook County, Illinois.

Parcel 2:

A parcel of land lying east of and adjoining the east line of Lot 6, south of and adjoining the south line of Lot 4, north of and adjoining the north line of Lots 7 and 8 and west of the line between Lots 8 and 9 projected north to its intersection with the southeasterly line of Lot 4, in Block 32 in Kinzie's Addition to Chicago in Section 10, Township 30 North, Range 14 East of the Third Principal Meridian, in Cook County, Illinois.

Parcel 3:

All that part of the north/south 18foot public alley lying east of the east line of Lots 1 to 4, both inclusive; lying west of the west line of Lot 27; lying south of a line drawn from the northeast corner of Lot 1 to the

#21177
INTRO DATE
OCT. 26, 2022

northwest corner of Lot 27; and lying north of the westwardly extension of the south line of Lot 27 all in subdivision of the west 394 feet of Block 32 (except the east 14 feet of the north 80 feet thereof) in Kinzie's Addition to Chicago, being a subdivision of the north fraction of Section 10, Township 39 North, Range 14 East of the Third Principal Meridian, in Cook County, Illinois.

COMMON ADDRESS: 201 - 221 E. Erie Street, 631 - 649 N. St. Clair Street and 200-212 E. Ontario Street

Planned Development #468, As Amended

Statements

1. The land delineated herein as Business Planned Development Number 468, as Amended (the "Planned Development") is owned by Chicago Title Land Trust Co, as successor trustee to LaSalle Bank NA, as successor trustee to American National Bank and Trust Company of Chicago, as Trustee, under Trust Number 121309-02. Northwestern Memorial HealthCare is the Applicant.
2. All applicable official reviews, approvals or permits are required to be obtained by the Applicant or its successors, assignees or grantees. Any dedication or vacation of streets or alleys, or easements, or adjustments of rights-of-way, or consolidation or resubdivision of parcels, shall require a separate submittal on behalf of the Applicant or its successors, assignees or grantees and approval by the City Council.
3. The requirements, obligations and conditions contained within this Planned Development shall be binding upon the Applicant, its successors and assigns and, if different from the Applicant, the legal title holder and any ground lessors. Furthermore, pursuant- to the requirements of Section 11.11-1 of the Chicago Zoning Ordinance, the Property shall be under single ownership or under single designated control at the time of any applications for amendments, modifications or changes (administrative, legislative or otherwise) to this Planned Development are made. Single designated control for purposes of this paragraph shall mean that any application to the City for any amendment to this Planned Development or any other modification or change thereto (administrative, legislative or otherwise) shall be made or authorized by all owners of the Property and any ground lessors.
4. This Plan of Development consists of these nineteen (19) statements; the bulk table, floor plans, program stacking diagrams, and building elevations. Exhibits on pages 52344, 52345, 52348 and 52349 of the City Council Journal as published on September 10, 1997 remain unchanged. Full-size sets of the Site/Landscape Plan and Building Elevations are on file with the Department of Planning and Development. The Planned Development is applicable to the area delineated hereto and these and no other zoning controls shall apply. In any instance where a provision of this Planned Development conflicts with the Chicago Building Code, the Building Code shall control.
5. The permitted uses in the Planned Development are as follows: medical service, business offices and related uses, hotel, ground floor retail and/or service establishments, restaurants with food and alcoholic beverage service, unenclosed or partially enclosed restaurants adjacent to and operated in conjunction with the enclosed restaurants, rooftop telecommunications and earth station receiving dishes which are appropriately screened, and accessory parking.
6. Off-street parking (for all uses except hotel use) and loading facilities will be provided on-site as currently constructed. Off-street parking for the hotel use

Applicant: Northwestern Memorial Healthcare

Address: 201 - 221 East Erie Street, 631 - 649 North St. Clair Street and 200-212 East Ontario Street

Introduction Date: October 26, 2022

shall be provided off-site pursuant to a long-term renewable lease (minimum of ten (10) years) to provide a minimum of fifty (50) weekday and one hundred fifty (150) weekend parking spaces in a parking facility not more than two (2) blocks from the proposed hotel.

7. On-premises signs and temporary signs, such as construction and marketing signs, shall be permitted within the Planned Development, subject to the review and approval of DPD. Off-premises signs are prohibited within the boundary of the Planned Development.
8. Any service drives or other ingress or egress shall be adequately designed and paved in accordance with the regulations of the Department of Transportation in effect at the time of construction and in compliance with the Municipal Code of the City of Chicago, to provide ingress and egress for motor vehicles, including emergency vehicles. There shall be no parking within such emergency areas. Ingress and egress shall be subject to the review and approval of the Department of Transportation and the Department of Planning and Development. The Applicant shall secure the permission of and execute any agreements which may be required by the City of Chicago in connection with the proposed curb relocation shown on the Site/Landscape Plan.
9. In addition to the maximum height of the buildings and any appurtenances thereto prescribed in this Planned Development, the height of the improvement shall be subject to height limitations as approved by the Federal Aviation Administration
10. The maximum permitted floor area ratio (FAR) for the Property shall be in accordance with the attached Bulk Regulations and Data Table. For the purpose of FAR calculations and measurements, the definitions in the Zoning Ordinance shall apply. The permitted FAR identified in the Bulk Regulations and Data Table has been determined using a net site area of 33,304 square feet.
11. Upon review and determination, "Part II Review", pursuant to Section 17-13-0610 of the Zoning Ordinance, a Part II Review fee shall be assessed by DPD. The fee, as determined by staff at the time, is final and binding on the Applicant and must be paid to the Department of Revenue prior to the issuance of any Part II Approval.
12. The improvements on the Property shall be designed, installed and maintained in substantial conformance with the Site/Landscape Plan and Building Elevations and in accordance with the parkway tree provisions of the Chicago Zoning Ordinance and corresponding regulations and guidelines.
13. The Applicant shall comply with Rules and Regulations for the Maintenance of Stockpiles promulgated by the Commissioners of the Departments of Streets and Sanitation, Fleet and Facility Management and Buildings, under Section 13-32-125, or any other provision of the Municipal Code of Chicago.
14. The terms and conditions of development under this Planned Development ordinance may be modified administratively, pursuant to Section 17-13-0611-A of the Chicago Zoning Ordinance, by the Zoning Administrator upon the application for such a modification by the Applicant, its successors or assigns and, if different than the Applicant, the legal titleholders and any ground lessors of the Property.
15. The Applicant acknowledges that it is in the public interest to design, construct and

Applicant: Northwestern Memorial Healthcare

Address: 201 - 221 East Erie Street, 631 - 649 North St. Clair Street and 200-212 East Ontario Street

Introduction Date: October 26, 2022

maintain the project in a manner which promotes, enables and maximizes universal access throughout the Property. Plans for all buildings and improvements on the Property shall be reviewed and approved by the Mayor's Office for People with Disabilities to ensure compliance with all applicable laws and regulations related to access for persons with disabilities and to promote the highest standard of accessibility.

16. The Applicant acknowledges that it is in the public interest to design, construct, renovate and maintain all buildings in a manner that provides healthier indoor environments, reduces operating costs and conserves energy and natural resources. The Applicant shall obtain the number of points necessary to meet the requirements of the Chicago Sustainable Development Policy, in effect at the time the Part II Review process is initiated, for each improvement that is subject to the aforementioned policy and must provide documentation verifying compliance.
17. The Applicant acknowledges that it is the policy of the City to maximize opportunities for Minority and Women-owned Business Enterprises ("M/WBEs") and city residents to compete for contracts and jobs on construction projects approved through the planned development process. To assist the city in promoting and tracking such M/WBE and city resident participation, an applicant for planned development approval shall provide information at three points in the city approval process. First, the applicant must submit to DPD, as part of its application for planned development approval, an M/WBE Participation Proposal. The M/WBE Participation Proposal must identify the applicant's goals for participation of certified M/WBE firms in the design, engineering and construction of the project, and of city residents in the construction work. The city encourages goals of (i) 26% MBE and 6% WBE participation (measured against the total construction budget for the project or any phase thereof), and (ii) 50% city resident hiring (measured against the total construction work hours for the project or any phase thereof). The M/WBE Participation Proposal must include a description of the Applicant's proposed outreach plan designed to inform M/WBEs and city residents of job and contracting opportunities. Second, at the time of the Applicant's submission for Part II permit review for the project or any phase thereof, the Applicant must submit to DPD (a) updates (if any) to the Applicant's preliminary outreach plan, (b) a description of the Applicant's outreach efforts and evidence of such outreach, including, without limitation, copies of certified letters to M/WBE contractor associations and the ward office of the alderman in which the project is located and receipts thereof; (c) responses to the Applicant's outreach efforts, and (d) updates (if any) to the applicant's M/WBE and city resident participation goals. Third, prior to issuance of a Certificate of Occupancy for the project or any phase thereof, the Applicant must provide DPD with the actual level of M/WBE and city resident participation in the project or any phase thereof, and evidence of such participation. In addition to the forgoing, DPD may request such additional information as the department determines may be necessary or useful in evaluating the extent to which M/WBEs and city residents are informed of and utilized in planned development projects. All such information will be provided in a form acceptable to the Zoning Administrator. DPD will report the data it collects regarding projected and actual employment of M/WBEs and city residents in planned development projects twice yearly to the Chicago Plan Commission and annually to the Chicago City Council and the Mayor.
18. The Applicant acknowledges that it is in the public interest to design, construct and maintain the project in a manner which promotes, enables and maximizes universal access throughout the Property. Plans for all buildings and

Applicant: Northwestern Memorial Healthcare

Address: 201 - 221 East Erie Street, 631 - 649 North St. Clair Street and 200-212 East Ontario Street

Introduction Date: October 26, 2022

improvements on the Property shall be reviewed and approved by the Mayor's Office for People with Disabilities to ensure compliance with all applicable laws and regulations related to access for persons with disabilities and to promote the highest standard of accessibility.

19. This Planned Development shall be governed by Section 17-13-0612 of the Zoning Ordinance. Should this Planned Development ordinance lapse, the Commissioner of DPD shall initiate a zoning map amendment to rezone the Property to Planned Development 468, as amended September 10, 1997.

Bulk Regulations And Data Table

Net Site Area (Square Feet/Acres)	Maximum Floor Area Ratio	Maximum Percent Site Coverage
33,304.29/0.76	18.42	In Accordance with the Site/ Landscape Plan.

Gross Site Area, 57,125 square feet = Net Site Area, 33,304.29 square feet/0.76 acres + Area Remaining in Public Right-of-Way, 23,820.71 square feet/0.55 acres.

Off-Street Parking (on-site)	Minimum 51 spaces for non-hotel uses.
Off-Street Parking (off-site within two blocks from Planned Development boundaries)	Minimum 50 spaces for hotel use (weekdays). Minimum 150 spaces for hotel use (weekends).
Off-Street Loading	Minimum 5 loading berths.

PROJECT STATEMENT

Current State: The project site (633 N. St. Clair St.) is zoned Business Planned Development 468 (most recently amended September 10, 1997) and consists of a mixed use business office, hotel, ground floor retail/service establishments, other related uses, and accessory parking contained within a single 27 story steel frame/glass curtain building with low-rise “ballroom addition”, all as provided in PD 468. The hotel portion is currently operated as Hyatt Centric Magnificent Mile Hotel (the “Hotel”) and occupies a portion of the first floor and floors 2-18 inclusive. The Hotel consists of 419 keys, along with guest amenity spaces and ballrooms/conference rooms.

The applicant, Northwestern Memorial HealthCare (NMHC), purchased the Hotel in February 2022. The project site is directly south of Northwestern Memorial Hospital's Galter Pavilion. East Erie Street separates the Hotel and Galter Pavilion. Galter Pavilion and its adjacent Feinberg Pavilion, along with other outpatient and non-clinical buildings, form the core of NMHC's academic medical center, Northwestern Memorial Hospital.

Project Plan: Repurposing two Hotel floors for Medical Services. In addition to leveraging the Hotel for use by its patients, their families, and visitors, NMHC wants to expand its academic medical center by repurposing two Hotel floors (5th and 6th floors, 20,576 SF and 36 keys per floor) for outpatient Medical Services (as defined in the current Zoning Ordinance). The Zoning Administrator advised NMHC that “business offices and related uses” under PD 468 does not permit the operation of Medical Services, so NMHC is seeking to amend to PD 468 “Plan of Development Statement #5” to include Medical Services.

To repurpose the 5th and 6th floors for Medical Services, NMHC intends to reconfigure the elevators serving those floors, which would require removal of two hotel rooms on the seventh floor. Thus, the total reduction in Hotel room keys by the repurposing the 5th and 6th floors to Medical Services would be 74, resulting in the Hotel having 345 keys after the Project is complete.

Pedestrian Bridge over East Erie. To ensure the safe and efficient passage of NMHC's patients and medical providers and staff between the repurposed Medical Services floors at 633 N. St. Clair and NMHC's academic medical center, NMHC intends to construct a pedestrian bridge connecting the second floor elevator lobby of the Hotel with Galter Pavilion. The new pedestrian bridge is minor change to PD 468 and a minor change to Institution Planned Development #3 (of which NMHC's academic medical campus is a part). NMHC will seek the minor change to PD 3 concurrently with these amendments to PD 468.

The pedestrian bridge will be approximately 15' wide and will span East Erie Street on a diagonal to the north and south buildings' faces. The structural design and connections will be limited to above the sidewalk and is conceived to not require additional column placement at the sidewalk level. The pedestrian bridge will meet the Chicago Building Code requirements, it will be a fully sprinklered structure, it will be fire rated and separated as required, and will not be used as a horizontal exit. The architectural language of the proposed bridge will be reflective of and in keeping with all other neighboring bridges that currently exist on NMHC's academic medical center, including the pedestrian bridge at the east end of the same block connecting NMHC's Feinberg Pavilion with its Lavin Family Outpatient building (permitted and developed by NMHC in 2013). In addition to providing protected access between the repurposed Medical Services space in 633 N. St. Clair, the pedestrian bridge will be fully accessible to

public circulation as are the other NMHC pedestrian bridges. The streetscape on the north side of East Erie is conceived to be consistent with the design language used in PD-3 and on the south side of East Erie is conceived to be consistent with the design language used in PD 468.

The new pedestrian bridge will consist of approximately 1,150 square feet of Floor Area, one half of which would be attributed to PD 468 and the other half attributed to PD 3. The addition of 575 sf of Floor Area to each PD will not cause either to exceed the currently permitted Floor Area Ratio:

- Current PD 468 FAR is 18.08 with assumed 603,667.52 building gross sf. With the addition of 575 sf, the resulting Floor Area Ratio would be 18.10, which is below PD 468 maximum Floor Area Ratio 18.42.
- After the 2020 minor change to PD 3 Subarea E (of which Galter Pavilion is a part) NMHC has available Floor Area Ratio of 516,889 square feet. The pedestrian bridge portion of Floor Area Ratio would reduce the Subarea E available Floor Area to 516,314 sf.

Except for this minor change to FAR due to the pedestrian bridge, NMHC's project will NOT change any bulk regulations data table or other changes to PD 468.

IV.Chicago Building Code:

Current 2021 Chicago Building Code has adopted IBC 2018

A.Occupancy Classification options of new pedestrian bridge:

1. Northwestern owns the bridge, it is classified “WITH” the base of Galter, in which case “E” Business.

B.Construction Type:

1. Assume the bridge to be I-A Construction type from Chicago Standpoint. Galter must have been I-A as a new high-rise compliant with 13-76.

C.Height and Area Limitations:

1. Unlimited for fully sprinklered 1-A building.
2. Bridges and Balconies: 13-160-510 Horizontal exits – Bridges and balconies.

(a) Bridges and balconies shall be constructed of noncombustible materials with solid floors. Railings shall comply with the requirements for railings of outside stairs.

(b) All exterior wall openings within a distance of 15 feet from balconies or bridges shall be protected by fire doors, fire windows or fire shutters as required in Section 15

Impact of recent changes to the Chicago Building code will need to be examined. Current Chicago Building Code requires both wind and seismic requirements to be addressed.

LEVEL 1 FLOOR PLAN

21,720 EXISTING GROSS SF

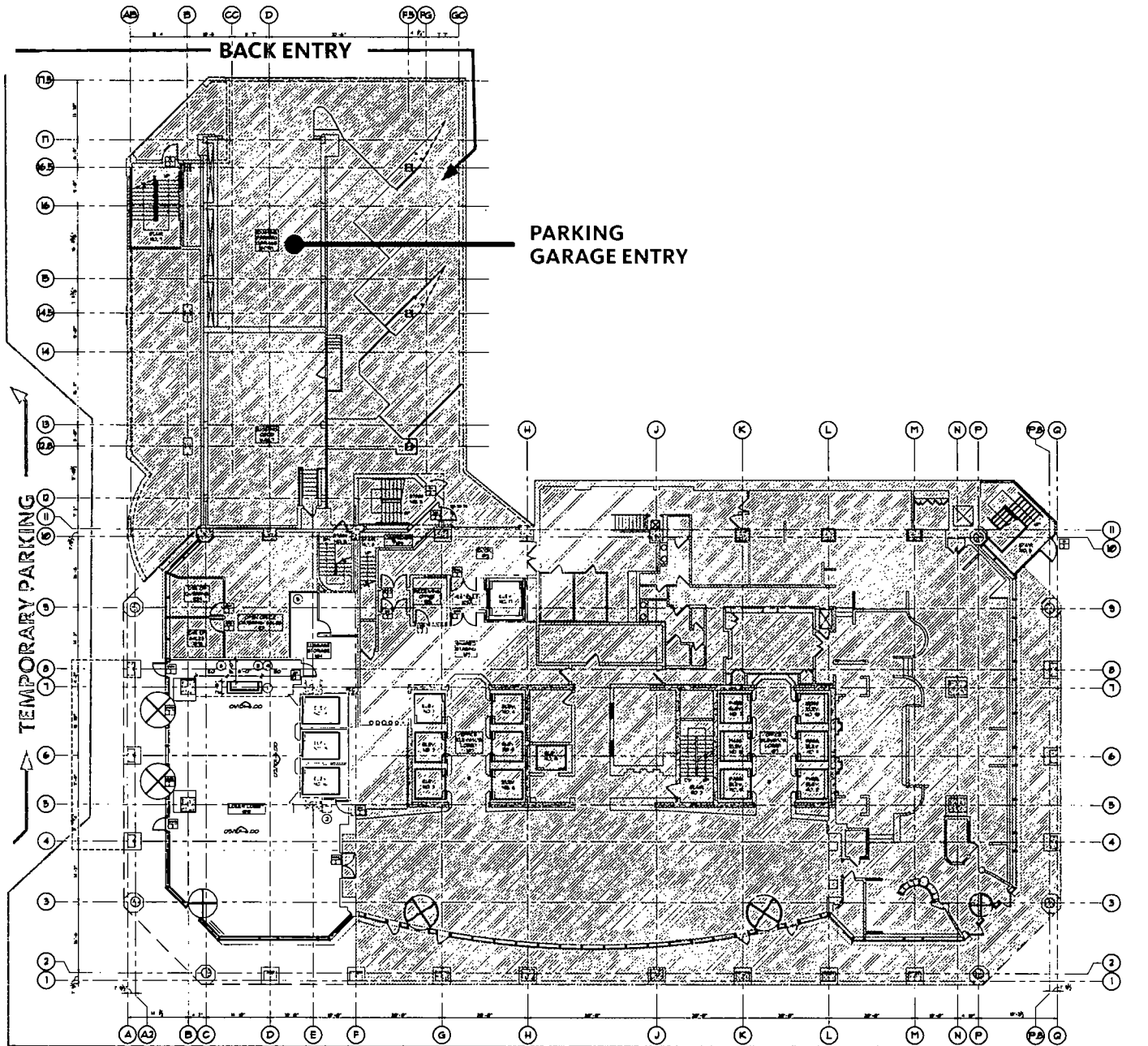

LEVEL 2 FLOOR PLAN

28,935 EXISTING GROSS SF

LIMITED SECOND FLOOR DEMOLITION REQUIRED
FOR CIRCULATION

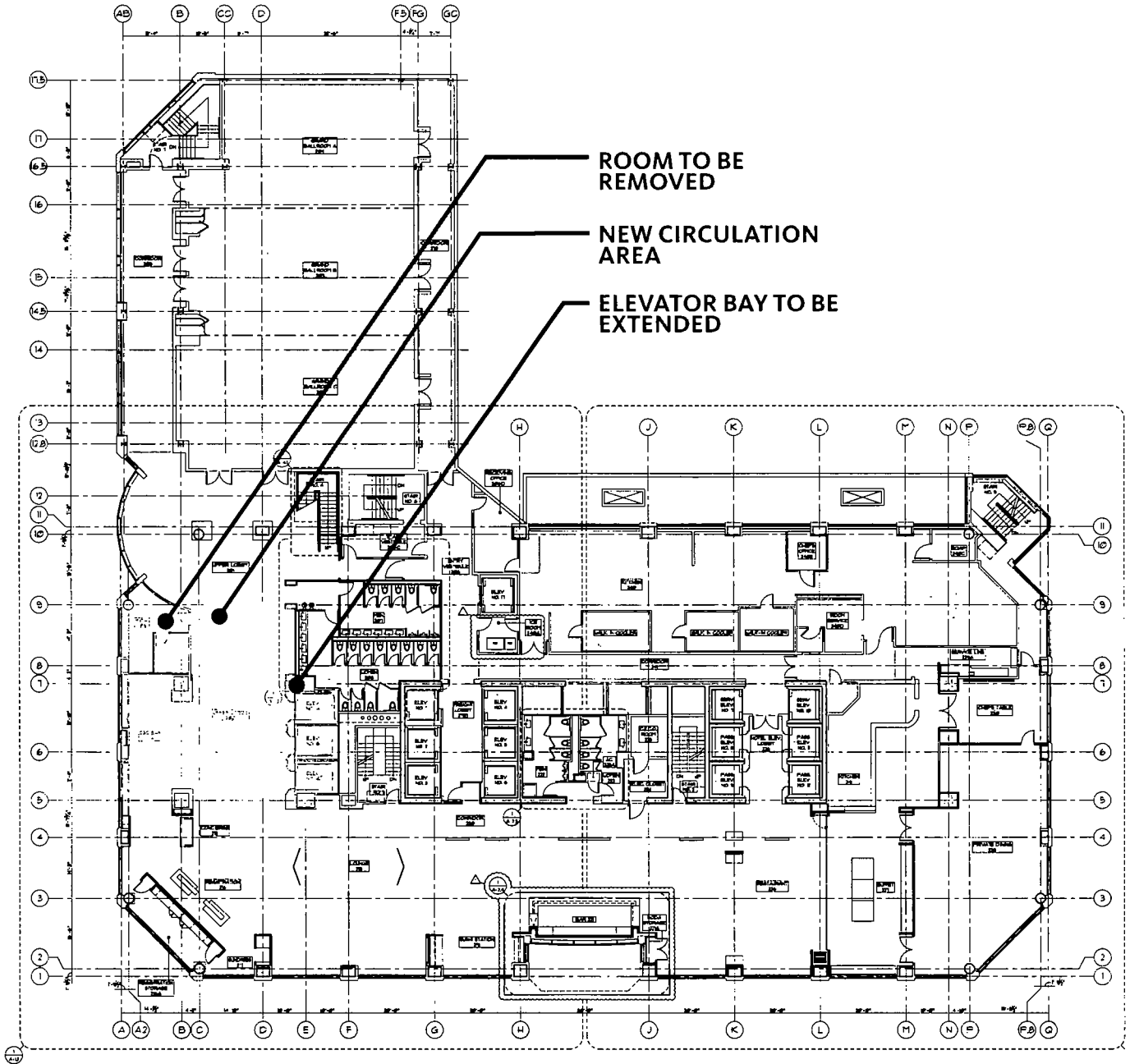

LEVEL 5 & 6 FLOOR PLAN

20,576 EXISTING GROSS SF

TO BE CONVERTED TO MEDICAL SERVICES

ELEVATOR EXTENSION

CHANGES TO FLOORS 5 & 6 INCLUDE REMOVAL OF 72 KEYS TOTAL:

- 16 SUITES
- 56 ROOMS

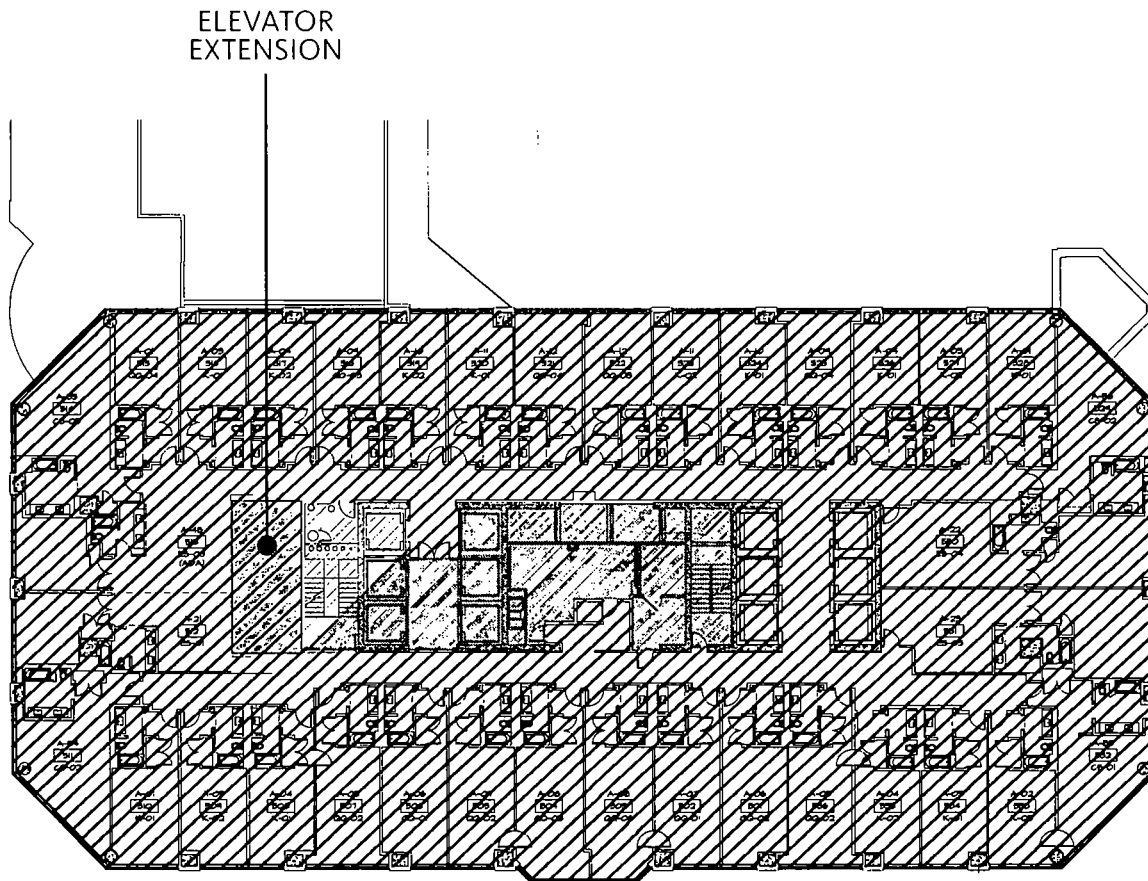

LEVEL 7 FLOOR PLAN

20,576 EXISTING GROSS SF

APPROX. 600 SF REQUIRED FOR ELEVATOR OVERRUN

REQUIRED DEMOLITION FOR ELEVATOR OVERRUN

2 KEYS TOTAL:

- 2 SUITES TO BE RECONFIGURED

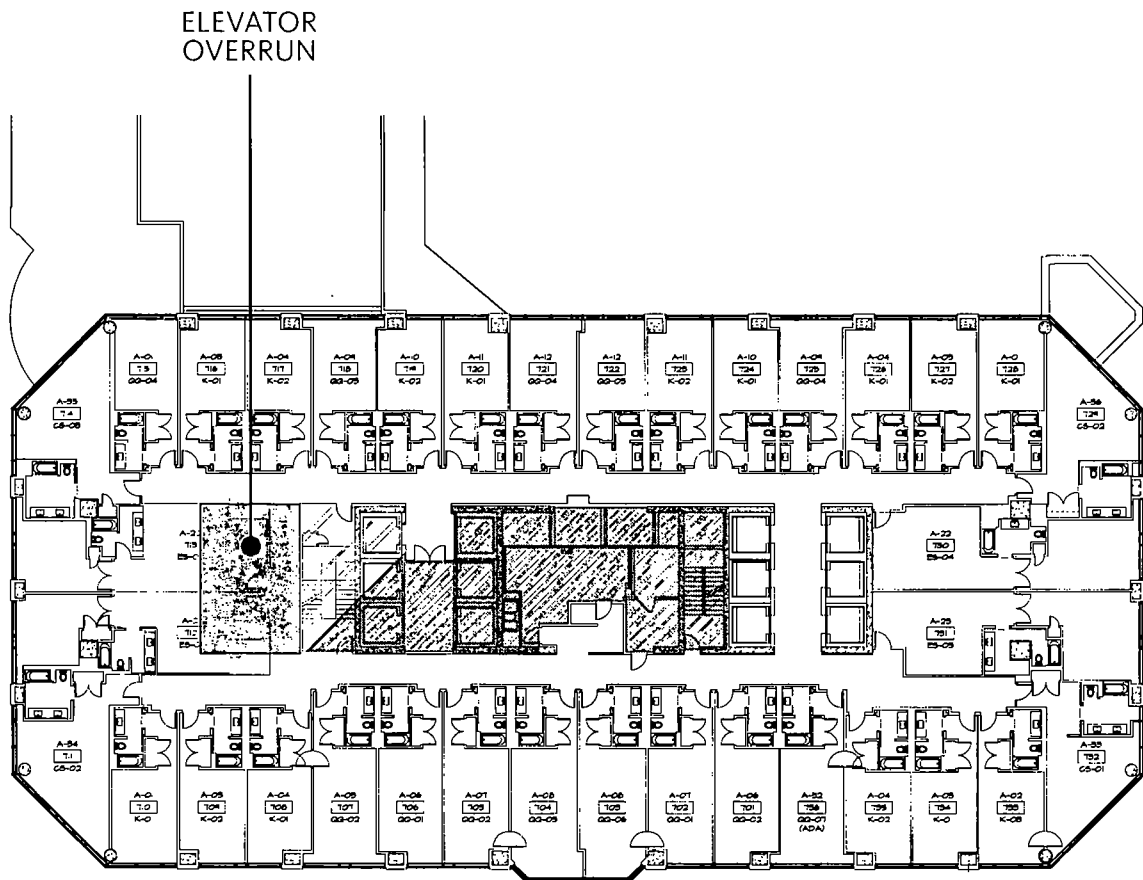

LEVEL 2 PROPOSED BRIDGE FLOOR PLAN

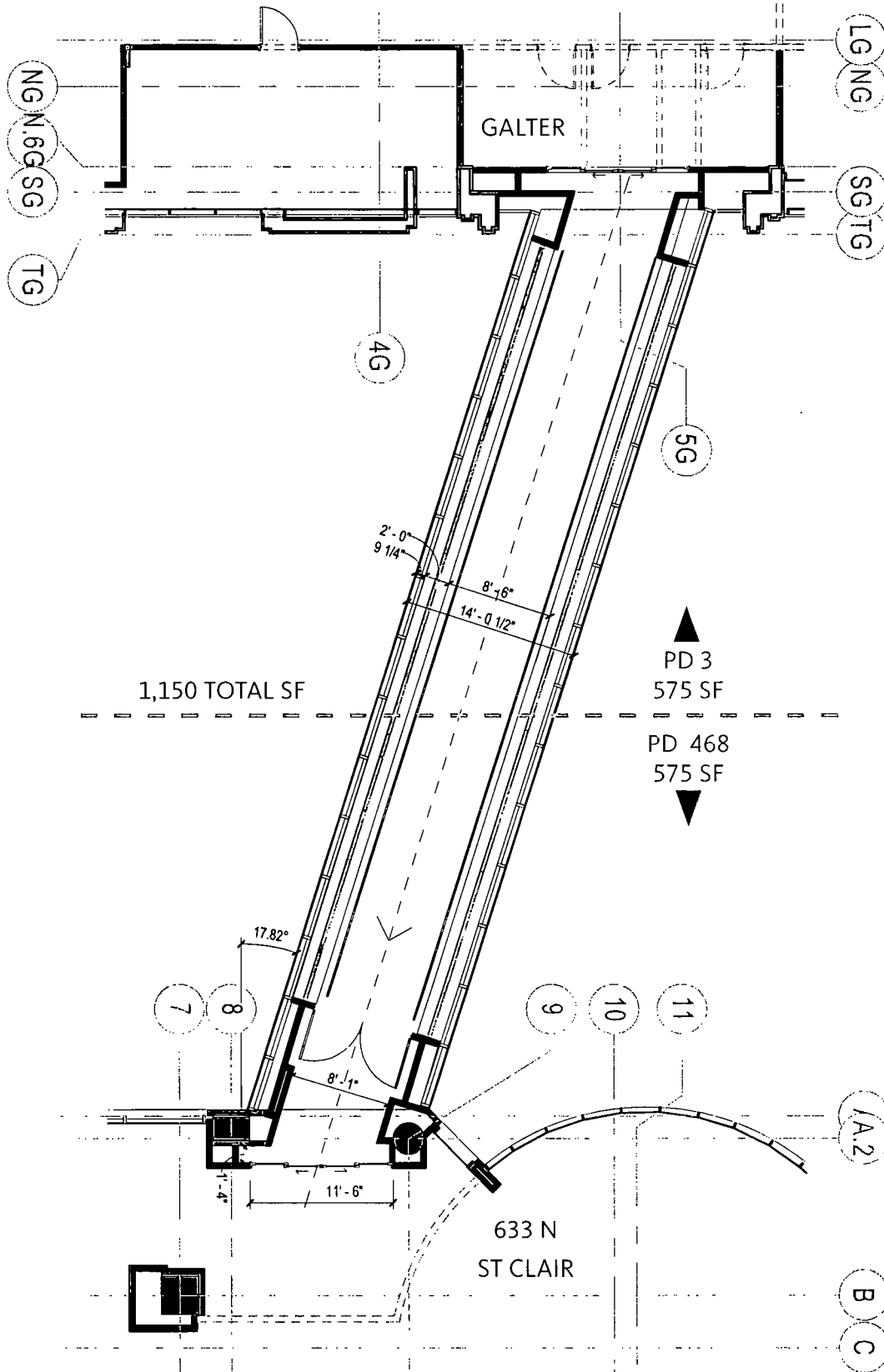

PD 468 PROGRAM STACKING DIAGRAM

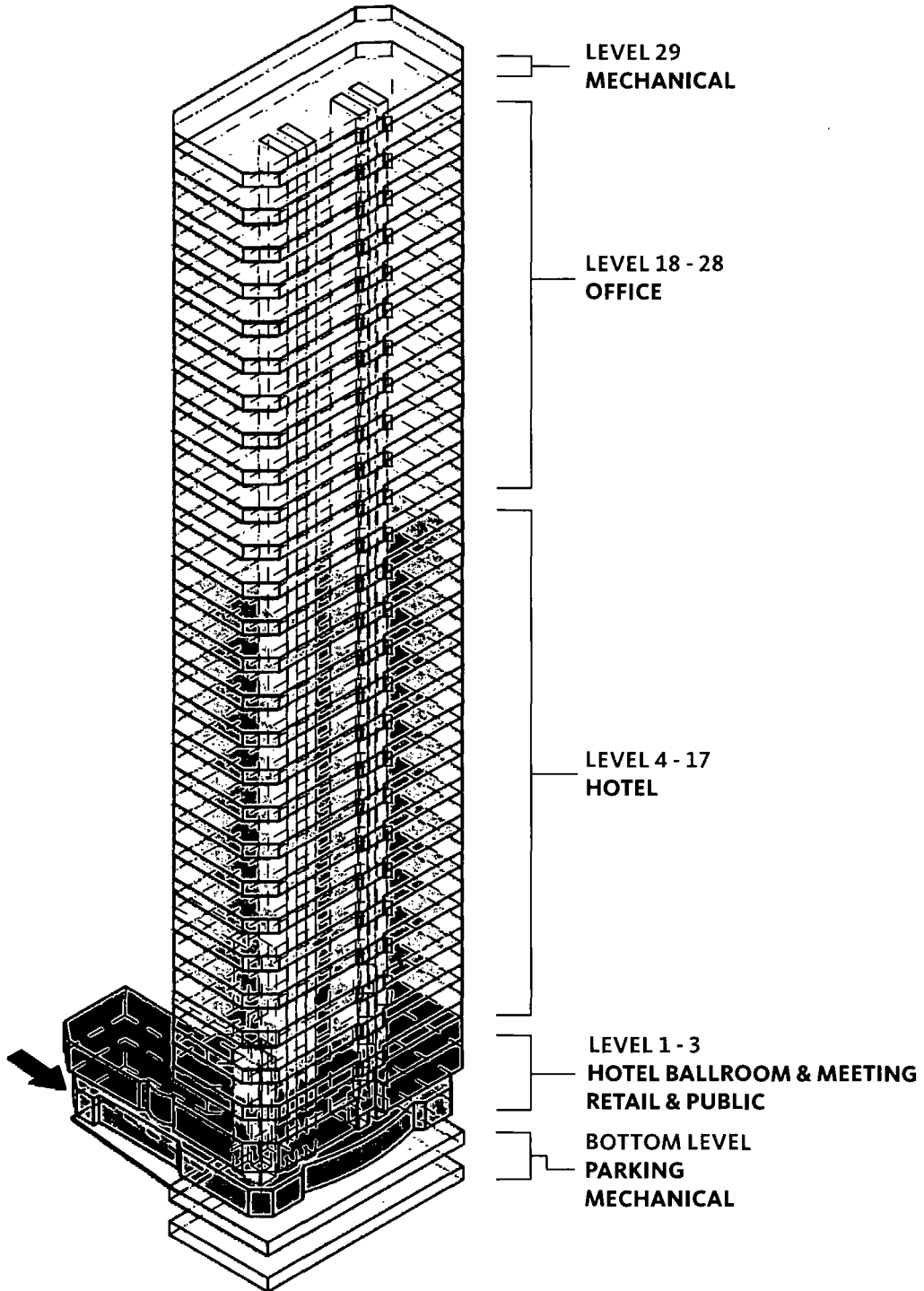

CURRENT CONDITION

PD 468 PROGRAM STACKING DIAGRAM

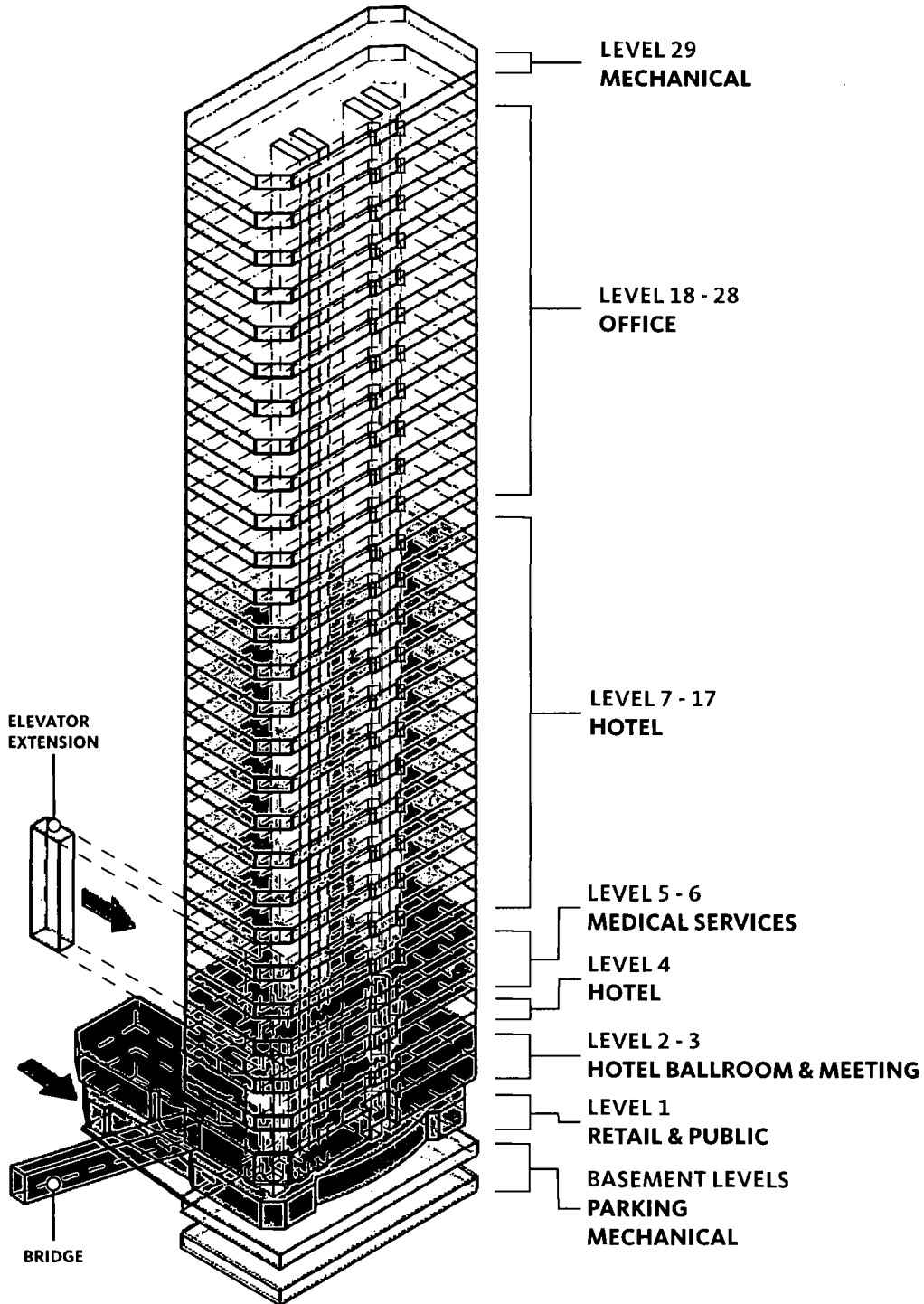

PROPOSED CHANGES

PD 468 ELEVATIONS

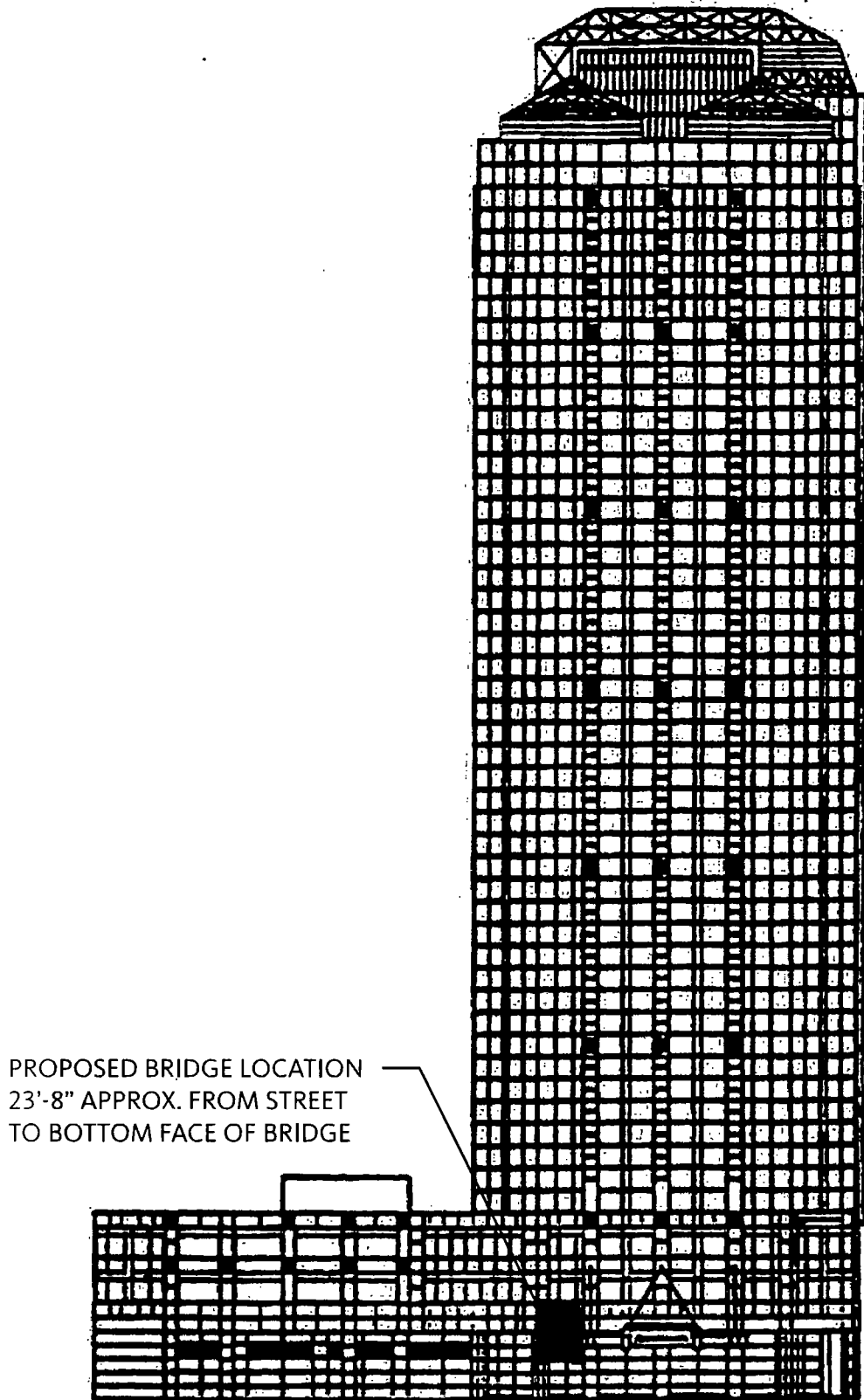

ELEVATION FACING SOUTH

FROM PAGE 52346 OF EXTRACT FOR PLANNED DEVELOPMENT 468

JOURNAL OF THE PROCEEDINGS OF THE CITY COUNCIL OF THE CITY OF CHICAGO, ILLINOIS

PD 468 ELEVATIONS

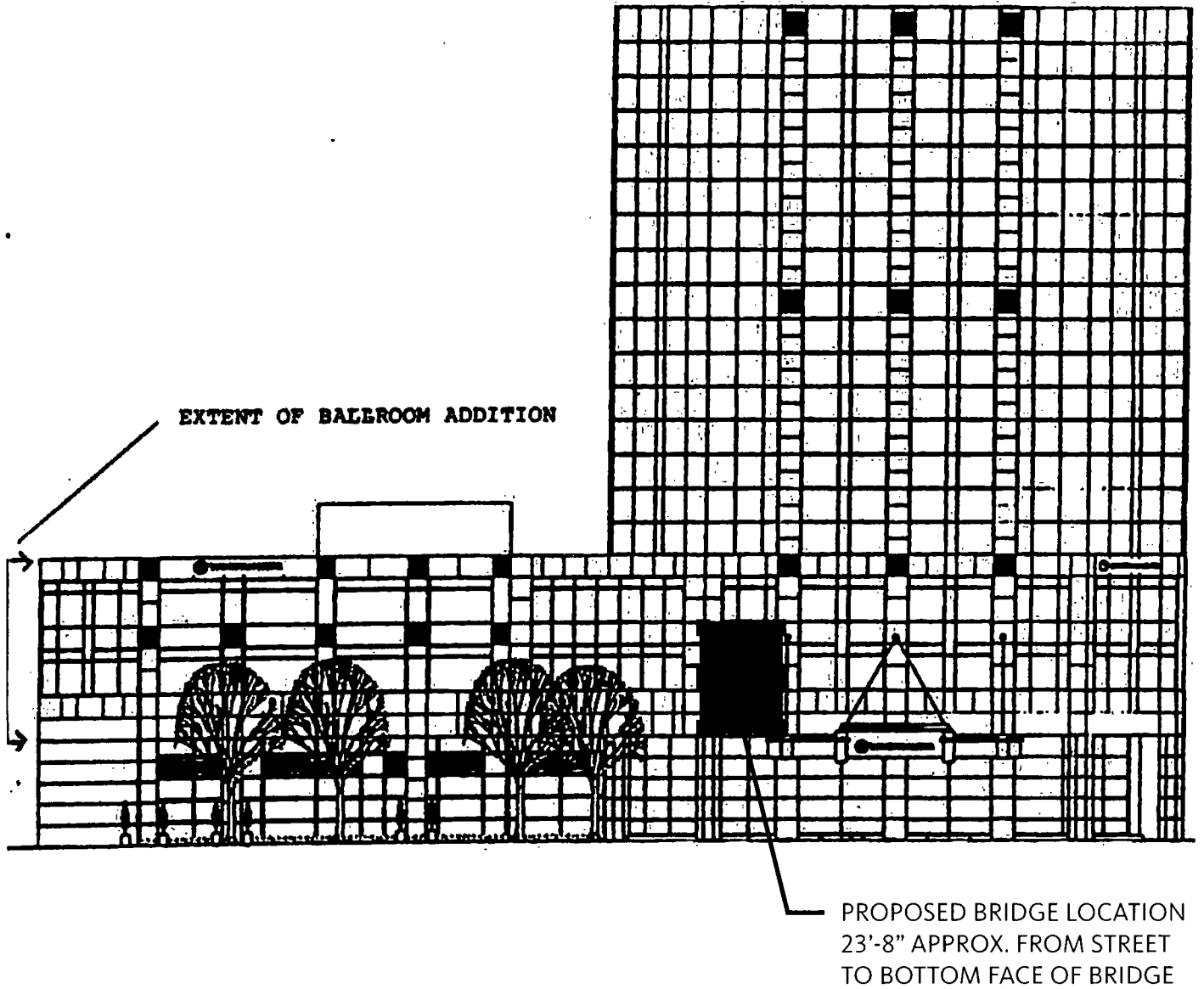

ELEVATION FACING SOUTH

FROM PAGE 52347 OF EXTRACT FOR PLANNED DEVELOPMENT 468

JOURNAL OF THE PROCEEDINGS OF THE CITY COUNCIL OF THE CITY OF CHICAGO, ILLINOIS

PD 468 ELEVATIONS

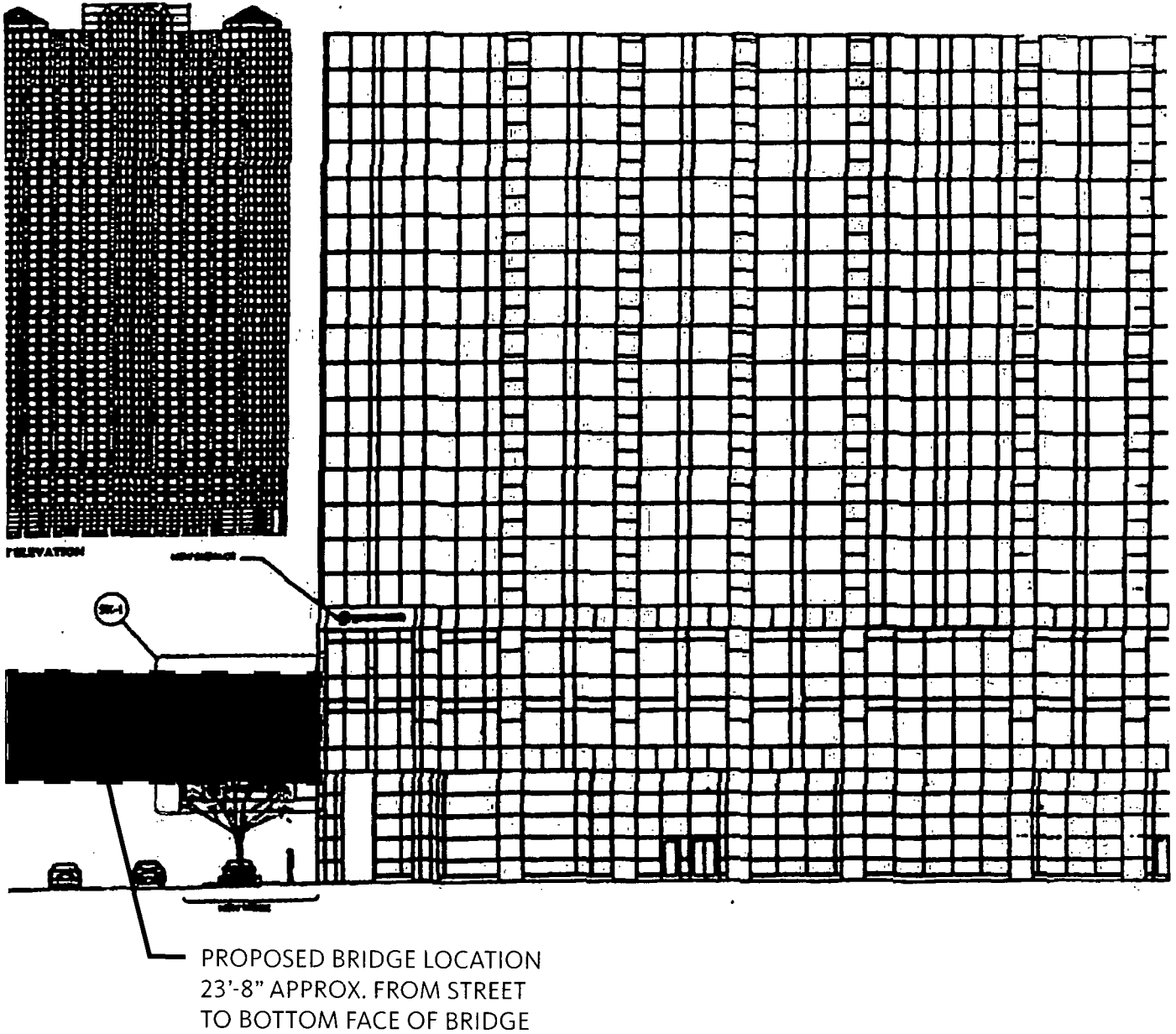

ELEVATION FACING EAST

FROM PAGE 52347 OF EXTRACT FOR PLANNED DEVELOPMENT 468

JOURNAL OF THE PROCEEDINGS OF THE CITY COUNCIL OF THE CITY OF CHICAGO, ILLINOIS

PD 468 ELEVATIONS

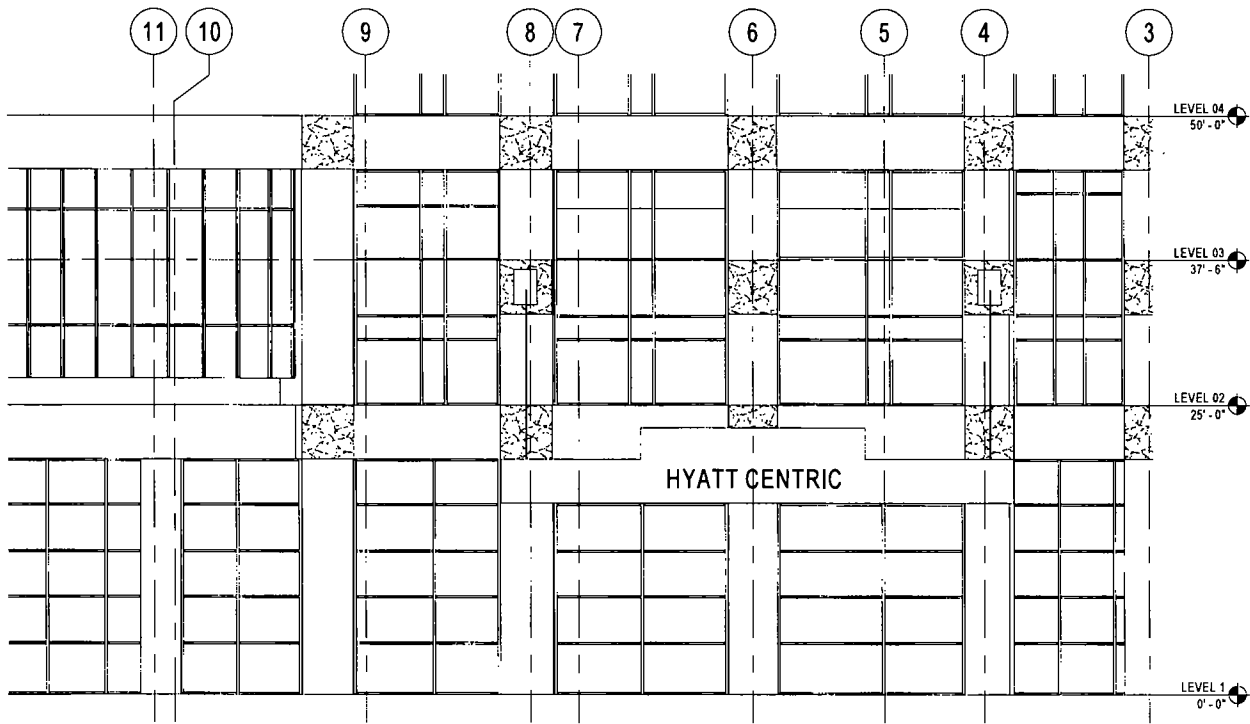

EXISTING ELEVATION FACING SOUTH

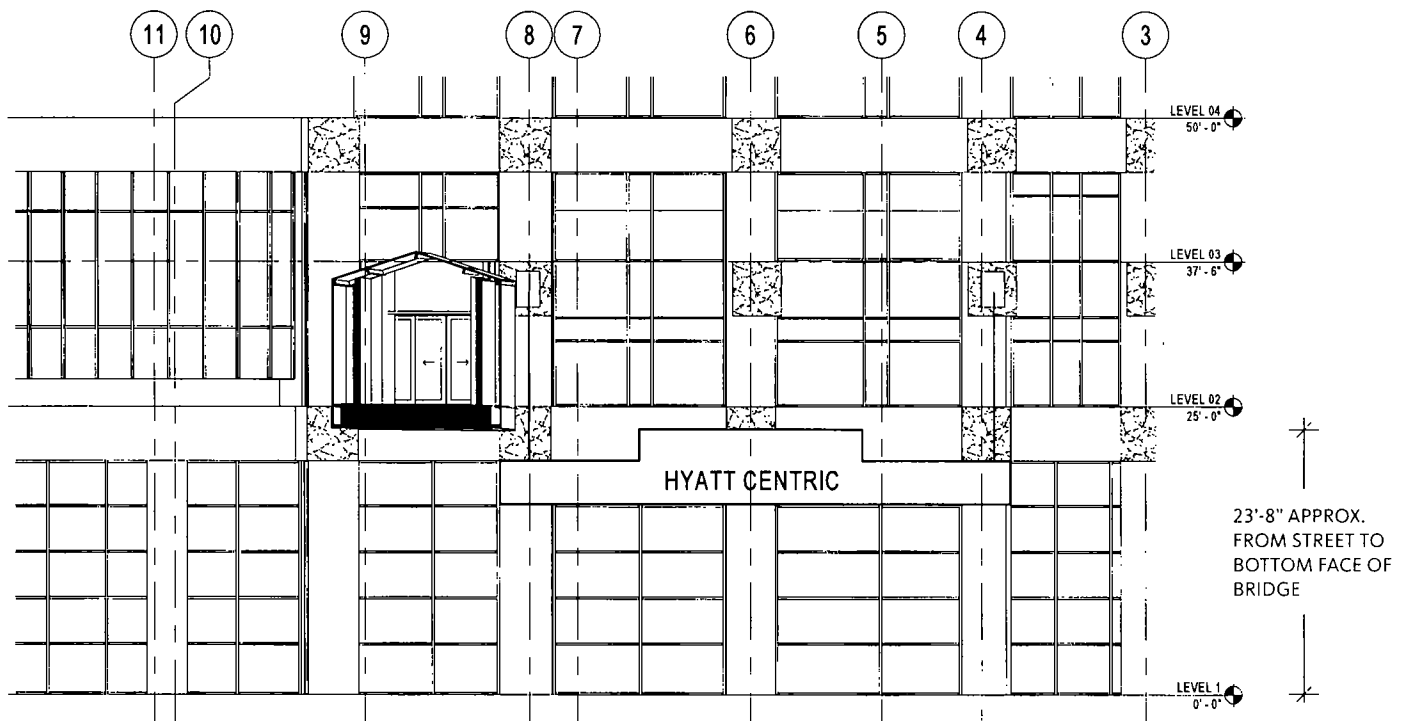

EXISTING ELEVATION FACING SOUTH

PD 468 ELEVATIONS

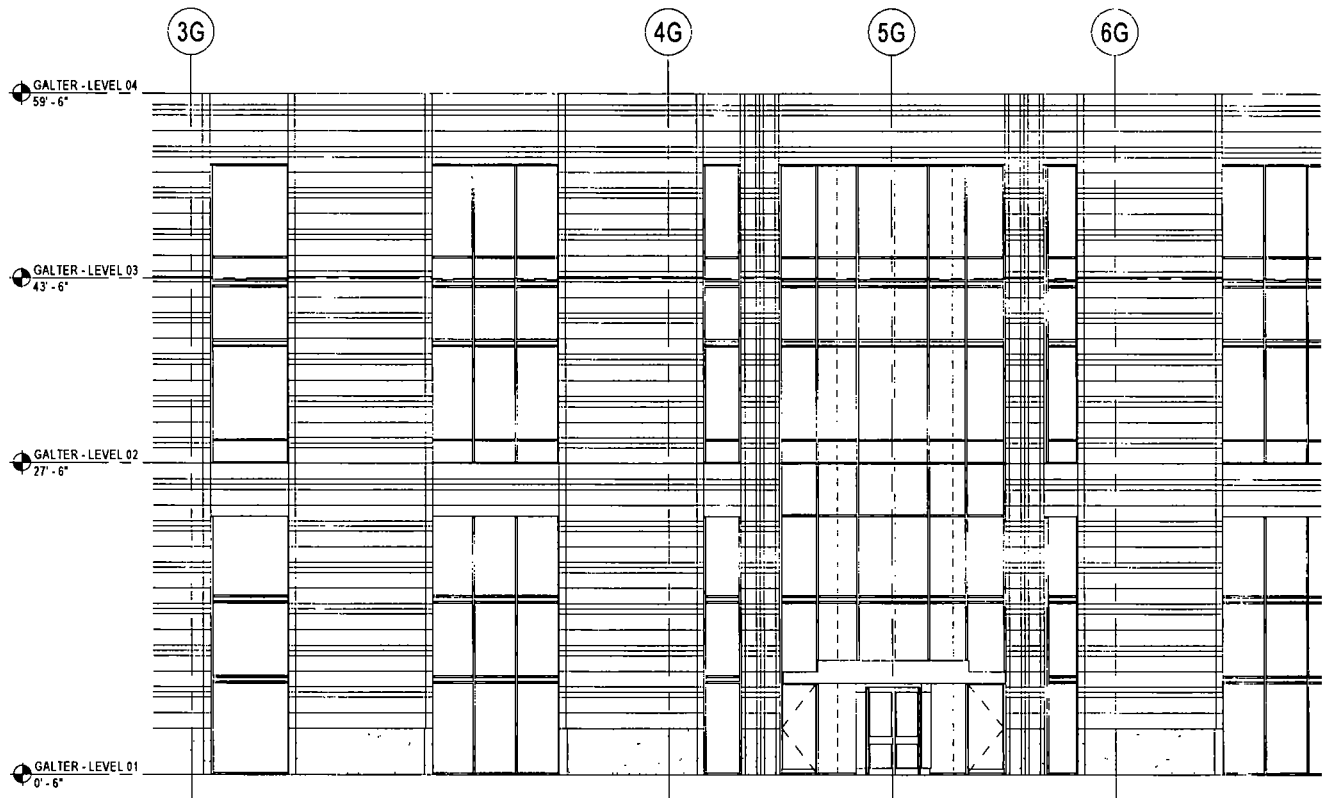

EXISTING ELEVATION FACING NORTH

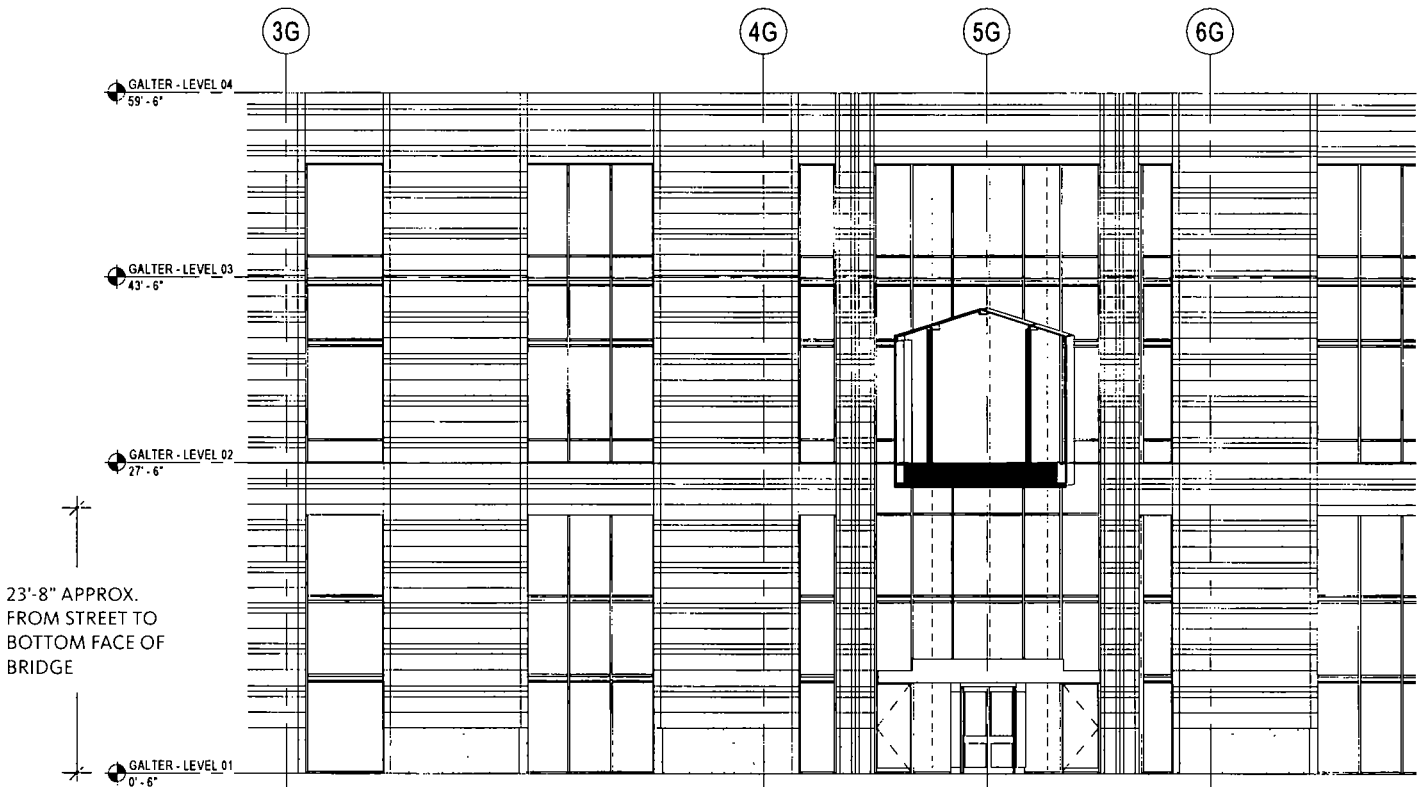

PROPOSED ELEVATION FACING NORTH

PROPOSED BRIDGE ELEVATION

EXISTING FEINBERG/LAVIN BRIDGE: 20' - 8" FROM STREET TO BOTTOM FACE

SUSTAINABILITY WILL BE CONSIDERED, BUT NOT A REQUIREMENT FOR PD AMENDMENT

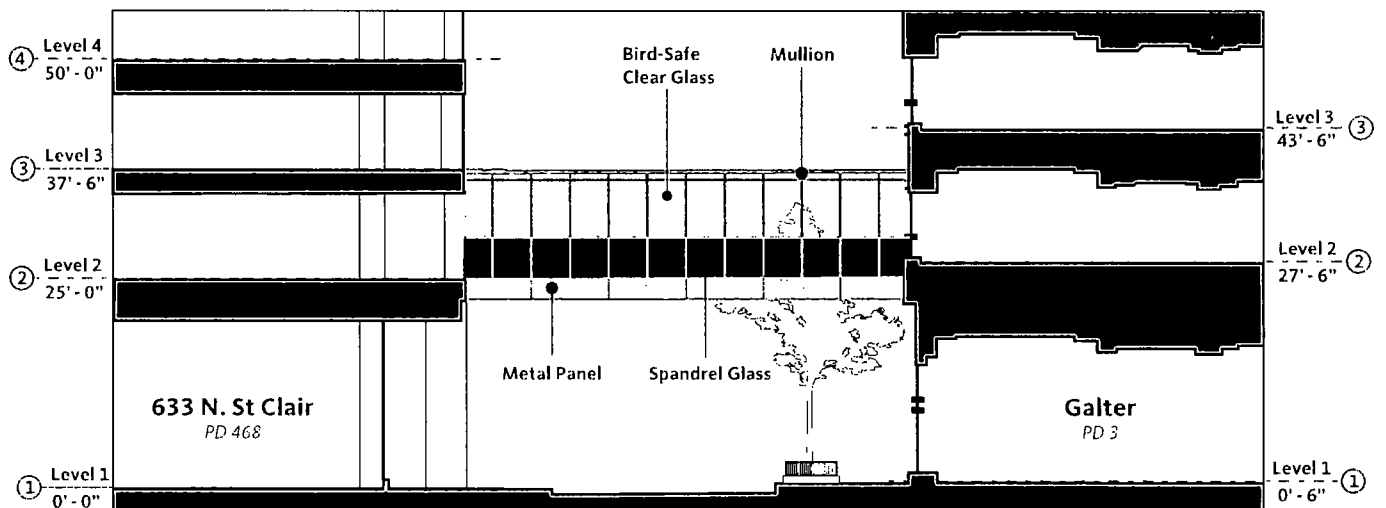
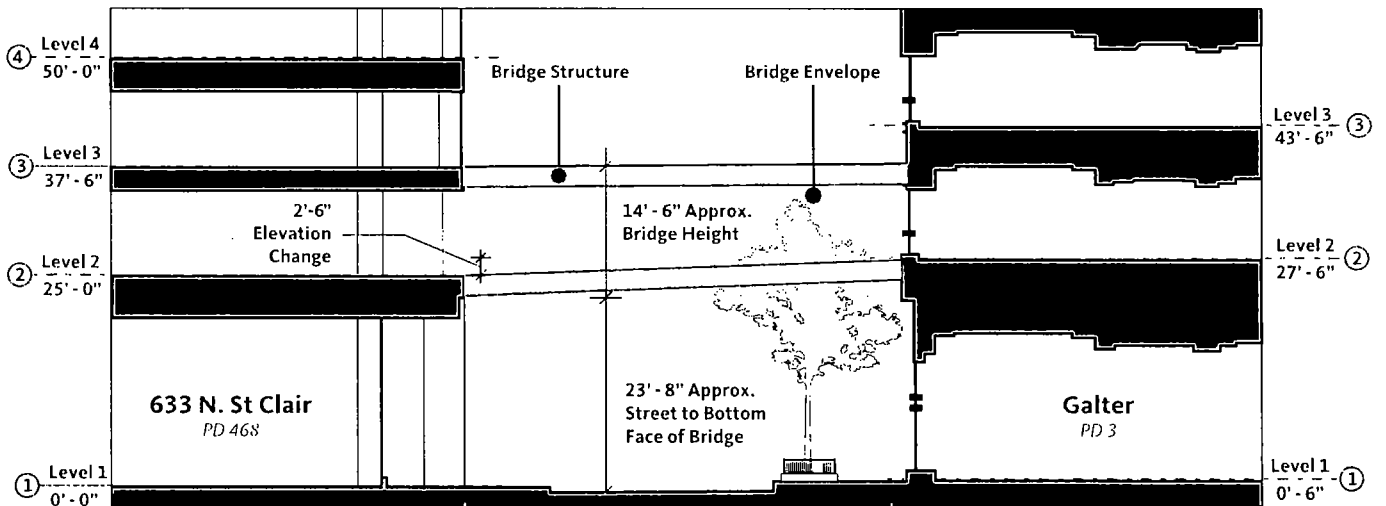

ELEVATION FACING WEST

#21177
INTRO DATE
OCT. 26, 2022

CITY OF CHICAGO

APPLICATION FOR AN AMENDMENT TO
THE CHICAGO ZONING ORDINANCE

1. ADDRESS of the property Applicant is seeking to rezone:
201 - 221 E. Erie Street, 631 - 649 N. St. Clair Street and 200-212 E. Ontario Street

2. Ward Number that property is located in: 42nd

3. APPLICANT Northwestern Memorial Healthcare
ADDRESS 211 E. Ontario, Suite 1700 CITY Chicago
STATE Illinois ZIP CODE 60611 PHONE 312.926.4103
EMAIL Thomas.Hefty@nm.org CONTACT PERSON Thomas Hefty

4. Is the applicant the owner of the property? YES X
NO _____ If the applicant is not the owner of the property, please provide the following information regarding the owner and attach written authorization from the owner allowing the application to proceed.

OWNER Chicago Title Land Trust Co, as successor trustee to LaSalle Bank NA, as successor trustee to American National Bank and Trust Company of Chicago, as Trustee, under Trust Number 121309-02, and is solely controlled by the beneficiary thereof, American College of Surgeons, Inc.
ADDRESS 10 S. La Salle St., Suite 2750 CITY Chicago
STATE IL ZIP CODE 60603 PHONE 312-202-5449
EMAIL gvincent@facs.org CONTACT PERSON Gay Vincent

5. If the Applicant/Owner of the property has obtained a lawyer as their representative for the rezoning, please provide the following information:

ATTORNEY Carol D. Stubblefield, Neal and Leroy, LLC
ADDRESS 20 S. Clark Street, Suite 2050
CITY Chicago STATE Illinois ZIP CODE 60603
PHONE 312-641-7144 FAX 312-641-5137 EMAIL cstubblefield@nealandleroy.com

6. If the applicant is a legal entity (Corporation, LLC, Partnership, etc.) please provide the names of all owners as disclosed on the Economic Disclosure Statements.

Please see attached

7. On what date did the owner acquire legal title to the subject property? 3/5/1996

8. Has the present owner previously rezoned this property? If yes, when?
Yes, it was amended 9/10/1997.

9. Present Zoning District PD 468, as amended Proposed Zoning District PD 468, as amended

10. Lot size in square feet (or dimensions) 33,304.29 square feet

11. Current Use of the property commerical uses development including hotel and office
Technical amendment to PD 468 to add medical service as a

12. Reason for rezoning the property permitted use.

13. Describe the proposed use of the property after the rezoning. Indicate the number of dwelling units; number of parking spaces; approximate square footage of any commercial space; and height of the proposed building. (BE SPECIFIC)

The property is improved with a commercial development that includes a hotel, ground floor retail/service establishments, other related uses, and accessory parking. The original PD did not include certain medical related uses. The amendment is necessary to include medical service as a permitted uses. A new pedestrian bridge over East Erie will be constructed to ensure the safe and efficient passage of Northwestern Memorial Healthcare's patients and medical providers and staff between the repurposed medical services floors at 633 N. St. Clair and Northwestern Medical Center Galter Pavilion.

14. The Affordable Requirements Ordinance (ARO) requires on-site affordable housing units and/or a financial contribution for residential housing projects with ten or more units that receive a zoning change which, among other triggers, increases the allowable floor area, or, for existing Planned Developments, increases the number of units (see attached fact sheet or visit www.cityofchicago.org/ARO for more information). Is this project subject to the ARO?

YES _____ NO x _____

COUNTY OF COOK
STATE OF ILLINOIS

Charles S Cloutier, being first duly sworn on oath, states that all of the above statements and the statements contained in the documents submitted herewith are true and correct.

Charles S Cloutier

Signature of Applicant

Subscribed and Sworn to before me this
11th day of October, 2022.

Amal Cardona
Notary Public

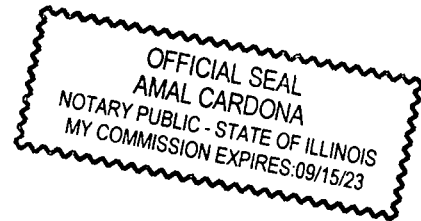

For Office Use Only

Date of Introduction: _____

File Number: _____

Ward: _____

NOTICE OF FILING OF REZONING APPLICATION

October 26, 2022

Dear Sir or Madam:

In accordance with the requirements of Section 17-13-0107 of the Municipal Code of the City of Chicago, please be informed that on or about October 26, 2022, the undersigned will file an application for a change in zoning from its current Planned Development Number 468 designation ("PD No. 468") to Planned Development Number 468, As Amended, on behalf of Northwestern Memorial HealthCare, (the "Applicant") for the property generally located at 201 - 221 E. Erie Street, 631 - 649 N. St. Clair Street and 200-212 E. Ontario Street (the "Property").

The property is improved with a commercial development that includes a hotel, ground floor retail/service establishments, other related uses, and accessory parking. The original PD did not include certain medical related uses. The amendment is necessary to include medical service as a permitted uses. A new pedestrian bridge over East Erie will be constructed to ensure the safe and efficient passage of Northwestern Memorial Healthcare's patients and medical providers and staff between the repurposed medical services floors at 633 N. St. Clair and Northwestern Medical Center Galter Pavilion.

The Property is owned by Chicago Title Land Trust Co, as successor trustee to LaSalle Bank NA, as successor trustee to American National Bank and Trust Company of Chicago, as Trustee, under Trust Number 121309-02 (the "Trustee"), and is solely controlled by the beneficiary thereof, American College of Surgeons, Inc., as Landlord. Contact information for the Trustee is 10 S. LaSalle Street, Suite 2750, attention Rachel Huitsing. Contact information for the Landlord is 633 N. St. Clair, Chicago, Illinois, 60611, attention Gay Vincent, 312-202-5449, gvincent@facs.org.

Northwestern Memorial HealthCare is the Applicant with offices located at 211 E. Ontario, Suite 1700, Chicago, IL 60611. Questions regarding the proposed Project or the Application may be addressed to Carol D. Stubblefield, Neal and Leroy, LLC, 20 S. Clark St., Ste. 2050, Chicago, IL 60603, (312) 641-7144.

PLEASE NOTE: THE APPLICANT IS NOT SEEKING TO REZONE OR PURCHASE YOUR PROPERTY. YOU ARE RECEIVING THIS NOTICE AS REQUIRED BY THE CHICAGO MUNICIPAL CODE BECAUSE COOK COUNTY TAX RECORDS INDICATE YOU OWN PROPERTY WITHIN 250 FEET OF THE BOUNDARIES OF THE SUBJECT PROPERTY.

Very truly yours,



Carol D. Stubblefield
Neal & Leroy, LLC

October 26, 2022

Thomas M. Tunney, Chairman
Committee on Zoning
Room 304, City Hall
121 North LaSalle Street
Chicago, Illinois 60602

Laura Flores, Chairwoman
Chicago Plan Commission
City Hall
121 North LaSalle Street
Chicago, Illinois 60602

**Re: Application for Rezoning
Affidavit of Notice**

Dear Chairman Tunney and Chairwoman Flores:

The undersigned, Carol D. Stubblefield, an attorney with the law firm of Neal & Leroy, LLC, which firm represents the Northwestern Memorial HealthCare, the applicant for an amendment to the Chicago Zoning Ordinance with respect to property generally located at 201 - 221 E. Erie Street, 631 - 649 N. St. Clair Street and 200-212 E. Ontario Street certifies that she has complied with the requirements of Section 17-13-0107 of the Municipal Code of the City of Chicago by sending the attached letter by United States Postal Service First Class Mail to the owners of all property within 250 feet in each direction of the subject property, as determined by the most recent Cook County tax records of Cook County, exclusive of public roads, streets, alleys and other public ways, or a total distance limited to 400 feet.

The undersigned certifies that the notice contains the common street address of the subject property, a description of the nature, scope and purpose of the application; the name and address of the Applicant; the name and address of the owner; the date the Applicant intends to file the applications on or about October 26, 2022.

The undersigned certifies that she has made a bona fide effort to determine the addresses of the parties to be notified under Section 17-13-0107 of the Municipal Code of the City of Chicago and that the Applicant certifies that the accompanying list of names and addresses of surrounding properties located within 250 feet of the subject property, is a complete list containing the names and last known addresses of the owners of the property required to be served.

Very truly yours,



Carol D. Stubblefield

Subscribed and sworn to before me
this 26th day of October, 2022

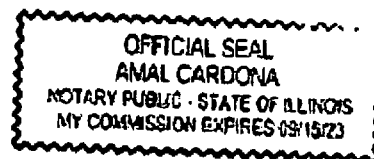
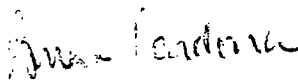

Notary Public



CHICAGO TITLE LAND TRUST COMPANY

10 S. LaSalle Street, Suite 2750, Chicago, IL 60603 Tel: (312)223-4110 Fax: (312)223-4139

February 24, 2022

Patrick Murphey
Zoning Administrator
Department of Planning and Development
Room 905, 121 North LaSalle Street
Chicago, IL 60602

Re: Property Owner's Consent to Seek Zoning Approvals – 633 N. St. Clair Street

Dear Mr. Murphey:

Chicago Title Land Trust Company, as successor trustee to LaSalle Bank National Association, as successor trustee to American National Bank and Trust Company of Chicago as trustee under Trust Agreement dated February 1, 1996 and known as Trust No. 121309-2 (the "Owner") is the owner of the property commonly known as 633 N. St. Clair Street, Chicago, IL (the "Property") (PIN: 17-10-203-001-0000 – 17-10-203-004-0000). The Property is currently improved as a 29-story office building including a Hyatt brand hotel with 419 rooms and other hotel amenities (the "Hyatt Hotel").

Owner has agreed that Northwestern Memorial Healthcare, an Illinois not-for-profit corporation ("NMHC"), which is the owner of the Hyatt Hotel, can seek zoning approvals (i) to repurpose two floors in the existing Hyatt Hotel for medical services, which is not currently a permitted use under the current planned development, and (ii) to build an elevated walkway over E. Erie that would connect the Hyatt Hotel and NMHC's Northwestern Memorial Hospital (the "Project"). The Owner and NMHC are each a party to a long-term Lease dated December 15, 1997, which defines the relationship between the parties.

Owner hereby authorizes NMHC, and its agents, to seek any zoning, land use approvals or opinions needed for the permitting and construction of the Project at this location, including, but not limited to, obtaining from the City of Chicago, Department of Planning and Development ("DPD") any existing zoning approvals, permits, plans and documents given to DPD, an amendment to PD468, a Grant of Privilege, a Building Permit, and any other approvals required.

If you have any questions about this consent letter, please do not hesitate to contact the Owner's attorney, Wesley Broquard at Wesley.Broquard@btlaw.com or (312) 214-8803.

Sincerely,

Chicago Title and Land Trust Company,
an Illinois Corporation, as Trustee



By: **RACHEL HUI TSING**

Its: **ASSISTANT VICE PRESIDENT**

(DO NOT SUBMIT THIS PAGE WITH YOUR EDS. The purpose of this page is for you to recertify your EDS prior to submission to City Council or on the date of closing. If unable to recertify truthfully, the Disclosing Party must complete a new EDS with correct or corrected information)

RECERTIFICATION

Generally, for use with City Council matters. Not for City procurements unless requested.

This recertification is being submitted in connection with Planned Development application for 633 N. St. Clair St. [identify the Matter]. Under penalty of perjury, the person signing below: (1) warrants that he/she is authorized to execute this EDS recertification on behalf of the Disclosing Party, (2) warrants that all certifications and statements contained in the Disclosing Party's original EDS are true, accurate and complete as of the date furnished to the City and continue to be true, accurate and complete as of the date of this recertification, and (3) reaffirms its acknowledgments.

Northwestern Memorial HealthCare
(Print or type legal name of Disclosing Party)

Date: 9/28/2022

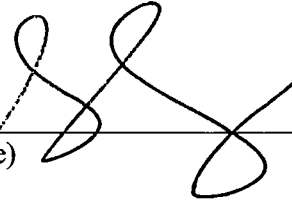
By: 

(sign here)

Print or type name of signatory:
Gina weldy

Title of signatory:
Senior Vice President, Administration

Signed and sworn to before me on [date] September 28, 2022, by Endia Latham, at Cook County, Illinois [state].

Endia Latham Notary Public.

Commission expires: 10.21.24

Ver. 11-01-05

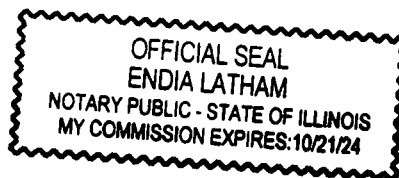

1
2
3
4
5
6
7
8
9
10
11
12
13
14
15
16
17
18
19
20
21
22
23
24
25
26
27
28
29
30
31
32
33
34
35
36
37
38
39
40
41
42
43
44
45
46
47
48
49
50
51
52
53
54
55
56
57
58
59
60
61
62
63
64
65
66
67
68
69
70
71
72
73
74
75
76
77
78
79
80
81
82
83
84
85
86
87
88
89
90
91
92
93
94
95
96
97
98
99
100

**CITY OF CHICAGO
ECONOMIC DISCLOSURE STATEMENT
AND AFFIDAVIT**

SECTION I -- GENERAL INFORMATION

A. Legal name of the Disclosing Party submitting this EDS. Include d/b/a/ if applicable:

Northwestern Memorial HealthCare

Check ONE of the following three boxes:

Indicate whether the Disclosing Party submitting this EDS is:

1. the Applicant

OR

2. a legal entity currently holding, or anticipated to hold within six months after City action on the contract, transaction or other undertaking to which this EDS pertains (referred to below as the "Matter"), a direct or indirect interest in excess of 7.5% in the Applicant. State the Applicant's legal name: _____

OR

3. a legal entity with a direct or indirect right of control of the Applicant (see Section II(B)(1)) State the legal name of the entity in which the Disclosing Party holds a right of control: _____

B. Business address of the Disclosing Party: 211 East Ontario Street, Suite 1800

Chicago, Illinois 60611

C. Telephone: 312-926-5771 Fax: _____ Email: thomas.hefty@nm.org

D. Name of contact person: Thomas L. Hefty, Sr. Associate General Counsel

E. Federal Employer Identification No. (if you have one): _____

F. Brief description of the Matter to which this EDS pertains. (Include project number and location of property, if applicable):

Planned Development application for 633 N. St. Clair Street

G. Which City agency or department is requesting this EDS? Department of Planning and Development

If the Matter is a contract being handled by the City's Department of Procurement Services, please complete the following:

Specification # _____ and Contract # _____

SECTION II -- DISCLOSURE OF OWNERSHIP INTERESTS

A. NATURE OF THE DISCLOSING PARTY

1. Indicate the nature of the Disclosing Party:

- Person
- Publicly registered business corporation
- Privately held business corporation
- Sole proprietorship
- General partnership
- Limited partnership
- Trust
- Limited liability company
- Limited liability partnership
- Joint venture
- Not-for-profit corporation
(Is the not-for-profit corporation also a 501(c)(3))?
 Yes No
- Other (please specify)

2. For legal entities, the state (or foreign country) of incorporation or organization, if applicable:

Illinois

3. For legal entities not organized in the State of Illinois: Has the organization registered to do business in the State of Illinois as a foreign entity?

- Yes
- No
- Organized in Illinois

B. IF THE DISCLOSING PARTY IS A LEGAL ENTITY:

1. List below the full names and titles, if applicable, of: (i) all executive officers and all directors of the entity; (ii) **for not-for-profit corporations**, all members, if any, which are legal entities (if there are no such members, write "no members which are legal entities"); (iii) **for trusts, estates or other similar entities**, the trustee, executor, administrator, or similarly situated party; (iv) **for general or limited partnerships, limited liability companies, limited liability partnerships or joint ventures**, each general partner, managing member, manager or any other person or legal entity that directly or indirectly controls the day-to-day management of the Applicant.

NOTE: Each legal entity listed below must submit an EDS on its own behalf.

Name Title

SEE ATTACHED SCHEDULE 1

2. Please provide the following information concerning each person or legal entity having a direct or indirect, current or prospective (i.e. within 6 months after City action) beneficial interest (including ownership) in excess of 7.5% of the Applicant. Examples of such an interest include shares in a corporation, partnership interest in a partnership or joint venture, interest of a member or manager in a

limited liability company, or interest of a beneficiary of a trust, estate or other similar entity. If none, state "None."

NOTE: Each legal entity listed below may be required to submit an EDS on its own behalf.

Name	Business Address	Percentage Interest in the Applicant
None.		

SECTION III -- INCOME OR COMPENSATION TO, OR OWNERSHIP BY, CITY ELECTED OFFICIALS

Has the Disclosing Party provided any income or compensation to any City elected official during the 12-month period preceding the date of this EDS? Yes No

Does the Disclosing Party reasonably expect to provide any income or compensation to any City elected official during the 12-month period following the date of this EDS? Yes No

If "yes" to either of the above, please identify below the name(s) of such City elected official(s) and describe such income or compensation:

Does any City elected official or, to the best of the Disclosing Party's knowledge after reasonable inquiry, any City elected official's spouse or domestic partner, have a financial interest (as defined in Chapter 2-156 of the Municipal Code of Chicago ("MCC")) in the Disclosing Party?

Yes No

If "yes," please identify below the name(s) of such City elected official(s) and/or spouse(s)/domestic partner(s) and describe the financial interest(s).

SECTION IV -- DISCLOSURE OF SUBCONTRACTORS AND OTHER RETAINED PARTIES

The Disclosing Party must disclose the name and business address of each subcontractor, attorney, lobbyist (as defined in MCC Chapter 2-156), accountant, consultant and any other person or entity whom the Disclosing Party has retained or expects to retain in connection with the Matter, as well as the nature of the relationship, and the total amount of the fees paid or estimated to be paid. The Disclosing Party is not required to disclose employees who are paid solely through the Disclosing Party's regular payroll. If the Disclosing Party is uncertain whether a disclosure is required under this Section, the Disclosing Party must either ask the City whether disclosure is required or make the disclosure.

Name (indicate whether retained or anticipated to be retained)	Business Address	Relationship to Disclosing Party (subcontractor, attorney, lobbyist, etc.)	Fees (<u>indicate whether paid or estimated.</u>) NOTE: "hourly rate" or "t.b.d." is not an acceptable response.
--	------------------	--	---

SEE ATTACHED SCHEDULE 2

(Add sheets if necessary)

Check here if the Disclosing Party has not retained, nor expects to retain, any such persons or entities.

SECTION V – CERTIFICATIONS

A. COURT-ORDERED CHILD SUPPORT COMPLIANCE

Under MCC Section 2-92-415, substantial owners of business entities that contract with the City must remain in compliance with their child support obligations throughout the contract's term.

Has any person who directly or indirectly owns 10% or more of the Disclosing Party been declared in arrearage on any child support obligations by any Illinois court of competent jurisdiction?

Yes No No person directly or indirectly owns 10% or more of the Disclosing Party.

If "Yes," has the person entered into a court-approved agreement for payment of all support owed and is the person in compliance with that agreement?

Yes No

B. FURTHER CERTIFICATIONS

1. [This paragraph 1 applies only if the Matter is a contract being handled by the City's Department of Procurement Services.] In the 5-year period preceding the date of this EDS, neither the Disclosing Party nor any Affiliated Entity [see definition in (5) below] has engaged, in connection with the performance of any public contract, the services of an integrity monitor, independent private sector inspector general, or integrity compliance consultant (i.e., an individual or entity with legal, auditing, investigative, or other similar skills, designated by a public agency to help the agency monitor the activity of specified agency vendors as well as help the vendors reform their business practices so they can be considered for agency contracts in the future, or continue with a contract in progress).

2. The Disclosing Party and its Affiliated Entities are not delinquent in the payment of any fine, fee, tax or other source of indebtedness owed to the City of Chicago, including, but not limited to, water and sewer charges, license fees, parking tickets, property taxes and sales taxes, nor is the Disclosing Party delinquent in the payment of any tax administered by the Illinois Department of Revenue.

3. The Disclosing Party and, if the Disclosing Party is a legal entity, all of those persons or entities identified in Section II(B)(1) of this EDS:

- a. are not presently debarred, suspended, proposed for debarment, declared ineligible or voluntarily excluded from any transactions by any federal, state or local unit of government;
- b. have not, during the 5 years before the date of this EDS, been convicted of a criminal offense, adjudged guilty, or had a civil judgment rendered against them in connection with: obtaining, attempting to obtain, or performing a public (federal, state or local) transaction or contract under a public transaction; a violation of federal or state antitrust statutes; fraud; embezzlement; theft; forgery; bribery; falsification or destruction of records; making false statements; or receiving stolen property;
- c. are not presently indicted for, or criminally or civilly charged by, a governmental entity (federal, state or local) with committing any of the offenses set forth in subparagraph (b) above;
- d. have not, during the 5 years before the date of this EDS, had one or more public transactions (federal, state or local) terminated for cause or default; and
- e. have not, during the 5 years before the date of this EDS, been convicted, adjudged guilty, or found liable in a civil proceeding, or in any criminal or civil action, including actions concerning environmental violations, instituted by the City or by the federal government, any state, or any other unit of local government.

4. The Disclosing Party understands and shall comply with the applicable requirements of MCC Chapters 2-56 (Inspector General) and 2-156 (Governmental Ethics).

5. Certifications (5), (6) and (7) concern:

- the Disclosing Party;
- any "Contractor" (meaning any contractor or subcontractor used by the Disclosing Party in connection with the Matter, including but not limited to all persons or legal entities disclosed under Section IV, "Disclosure of Subcontractors and Other Retained Parties");
- any "Affiliated Entity" (meaning a person or entity that, directly or indirectly: controls the Disclosing Party, is controlled by the Disclosing Party, or is, with the Disclosing Party, under common control of another person or entity). Indicia of control include, without limitation: interlocking management or ownership; identity of interests among family members, shared facilities and equipment; common use of employees; or organization of a business entity following the ineligibility of a business entity to do business with federal or state or local government, including the City, using substantially the same management, ownership, or principals as the ineligible entity. With respect to Contractors, the term Affiliated Entity means a person or entity that directly or indirectly controls the Contractor, is controlled by it, or, with the Contractor, is under common control of another person or entity;
- any responsible official of the Disclosing Party, any Contractor or any Affiliated Entity or any other official, agent or employee of the Disclosing Party, any Contractor or any Affiliated Entity, acting pursuant to the direction or authorization of a responsible official of the Disclosing Party, any Contractor or any Affiliated Entity (collectively "Agents").

Neither the Disclosing Party, nor any Contractor, nor any Affiliated Entity of either the Disclosing Party or any Contractor, nor any Agents have, during the 5 years before the date of this EDS, or, with respect to a Contractor, an Affiliated Entity, or an Affiliated Entity of a Contractor during the 5 years before the date of such Contractor's or Affiliated Entity's contract or engagement in connection with the Matter:

- a. bribed or attempted to bribe, or been convicted or adjudged guilty of bribery or attempting to bribe, a public officer or employee of the City, the State of Illinois, or any agency of the federal government or of any state or local government in the United States of America, in that officer's or employee's official capacity;
 - b. agreed or colluded with other bidders or prospective bidders, or been a party to any such agreement, or been convicted or adjudged guilty of agreement or collusion among bidders or prospective bidders, in restraint of freedom of competition by agreement to bid a fixed price or otherwise; or
 - c. made an admission of such conduct described in subparagraph (a) or (b) above that is a matter of record, but have not been prosecuted for such conduct; or
 - d. violated the provisions referenced in MCC Subsection 2-92-320(a)(4)(Contracts Requiring a Base Wage); (a)(5)(Debarment Regulations); or (a)(6)(Minimum Wage Ordinance).
6. Neither the Disclosing Party, nor any Affiliated Entity or Contractor, or any of their employees, officials, agents or partners, is barred from contracting with any unit of state or local government as a result of engaging in or being convicted of (1) bid-rigging in violation of 720 ILCS 5/33E-3; (2) bid-rotating in violation of 720 ILCS 5/33E-4; or (3) any similar offense of any state or of the United States of America that contains the same elements as the offense of bid-rigging or bid-rotating.
7. Neither the Disclosing Party nor any Affiliated Entity is listed on a Sanctions List maintained by the United States Department of Commerce, State, or Treasury, or any successor federal agency.
8. [FOR APPLICANT ONLY] (i) Neither the Applicant nor any "controlling person" [see MCC Chapter 1-23, Article I for applicability and defined terms] of the Applicant is currently indicted or charged with, or has admitted guilt of, or has ever been convicted of, or placed under supervision for, any criminal offense involving actual, attempted, or conspiracy to commit bribery, theft, fraud, forgery, perjury, dishonesty or deceit against an officer or employee of the City or any "sister agency"; and (ii) the Applicant understands and acknowledges that compliance with Article I is a continuing requirement for doing business with the City. NOTE: If MCC Chapter 1-23, Article I applies to the Applicant, that Article's permanent compliance timeframe supersedes 5-year compliance timeframes in this Section V.
9. [FOR APPLICANT ONLY] The Applicant and its Affiliated Entities will not use, nor permit their subcontractors to use, any facility listed as having an active exclusion by the U.S. EPA on the federal System for Award Management ("SAM").
10. [FOR APPLICANT ONLY] The Applicant will obtain from any contractors/subcontractors hired or to be hired in connection with the Matter certifications equal in form and substance to those in Certifications (2) and (9) above and will not, without the prior written consent of the City, use any such

contractor/subcontractor that does not provide such certifications or that the Applicant has reason to believe has not provided or cannot provide truthful certifications.

11. If the Disclosing Party is unable to certify to any of the above statements in this Part B (Further Certifications), the Disclosing Party must explain below:

NA

If the letters "NA," the word "None," or no response appears on the lines above, it will be conclusively presumed that the Disclosing Party certified to the above statements.

12. To the best of the Disclosing Party's knowledge after reasonable inquiry, the following is a complete list of all current employees of the Disclosing Party who were, at any time during the 12-month period preceding the date of this EDS, an employee, or elected or appointed official, of the City of Chicago (if none, indicate with "N/A" or "none").

NA

13. To the best of the Disclosing Party's knowledge after reasonable inquiry, the following is a complete list of all gifts that the Disclosing Party has given or caused to be given, at any time during the 12-month period preceding the execution date of this EDS, to an employee, or elected or appointed official, of the City of Chicago. For purposes of this statement, a "gift" does not include: (i) anything made generally available to City employees or to the general public, or (ii) food or drink provided in the course of official City business and having a retail value of less than \$25 per recipient, or (iii) a political contribution otherwise duly reported as required by law (if none, indicate with "N/A" or "none"). As to any gift listed below, please also list the name of the City recipient.

NA

C. CERTIFICATION OF STATUS AS FINANCIAL INSTITUTION

1. The Disclosing Party certifies that the Disclosing Party (check one)

is is not

a "financial institution" as defined in MCC Section 2-32-455(b).

2. If the Disclosing Party IS a financial institution, then the Disclosing Party pledges:

"We are not and will not become a predatory lender as defined in MCC Chapter 2-32. We further pledge that none of our affiliates is, and none of them will become, a predatory lender as defined in MCC Chapter 2-32. We understand that becoming a predatory lender or becoming an affiliate of a predatory lender may result in the loss of the privilege of doing business with the City."

If the Disclosing Party is unable to make this pledge because it or any of its affiliates (as defined in MCC Section 2-32-455(b)) is a predatory lender within the meaning of MCC Chapter 2-32, explain here (attach additional pages if necessary):

If the letters "NA," the word "None," or no response appears on the lines above, it will be conclusively presumed that the Disclosing Party certified to the above statements.

D. CERTIFICATION REGARDING FINANCIAL INTEREST IN CITY BUSINESS

Any words or terms defined in MCC Chapter 2-156 have the same meanings if used in this Part D.

1. In accordance with MCC Section 2-156-110: To the best of the Disclosing Party's knowledge after reasonable inquiry, does any official or employee of the City have a financial interest in his or her own name or in the name of any other person or entity in the Matter?

Yes No

NOTE: If you checked "Yes" to Item D(1), proceed to Items D(2) and D(3). If you checked "No" to Item D(1), skip Items D(2) and D(3) and proceed to Part E.

2. Unless sold pursuant to a process of competitive bidding, or otherwise permitted, no City elected official or employee shall have a financial interest in his or her own name or in the name of any other person or entity in the purchase of any property that (i) belongs to the City, or (ii) is sold for taxes or assessments, or (iii) is sold by virtue of legal process at the suit of the City (collectively, "City Property Sale"). Compensation for property taken pursuant to the City's eminent domain power does not constitute a financial interest within the meaning of this Part D.

Does the Matter involve a City Property Sale?

Yes No

3. If you checked "Yes" to Item D(1), provide the names and business addresses of the City officials or employees having such financial interest and identify the nature of the financial interest:

Name	Business Address	Nature of Financial Interest

4. The Disclosing Party further certifies that no prohibited financial interest in the Matter will be acquired by any City official or employee.

E. CERTIFICATION REGARDING SLAVERY ERA BUSINESS

Please check either (1) or (2) below. If the Disclosing Party checks (2), the Disclosing Party must disclose below or in an attachment to this EDS all information required by (2). Failure to comply with these disclosure requirements may make any contract entered into with the City in connection with the Matter voidable by the City.

1. The Disclosing Party verifies that the Disclosing Party has searched any and all records of the Disclosing Party and any and all predecessor entities regarding records of investments or profits from slavery or slaveholder insurance policies during the slavery era (including insurance policies issued to slaveholders that provided coverage for damage to or injury or death of their slaves), and the Disclosing Party has found no such records.

2. The Disclosing Party verifies that, as a result of conducting the search in step (1) above, the Disclosing Party has found records of investments or profits from slavery or slaveholder insurance policies. The Disclosing Party verifies that the following constitutes full disclosure of all such records, including the names of any and all slaves or slaveholders described in those records:

SECTION VI -- CERTIFICATIONS FOR FEDERALLY FUNDED MATTERS

NOTE: If the Matter is federally funded, complete this Section VI. If the Matter is not federally funded, proceed to Section VII. For purposes of this Section VI, tax credits allocated by the City and proceeds of debt obligations of the City are not federal funding.

A. CERTIFICATION REGARDING LOBBYING

1. List below the names of all persons or entities registered under the federal Lobbying Disclosure Act of 1995, as amended, who have made lobbying contacts on behalf of the Disclosing Party with respect to the Matter: (Add sheets if necessary):

(If no explanation appears or begins on the lines above, or if the letters "NA" or if the word "None" appear, it will be conclusively presumed that the Disclosing Party means that NO persons or entities registered under the Lobbying Disclosure Act of 1995, as amended, have made lobbying contacts on behalf of the Disclosing Party with respect to the Matter.)

2. The Disclosing Party has not spent and will not expend any federally appropriated funds to pay any person or entity listed in paragraph A(1) above for his or her lobbying activities or to pay any person or entity to influence or attempt to influence an officer or employee of any agency, as defined by applicable federal law, a member of Congress, an officer or employee of Congress, or an employee

of a member of Congress, in connection with the award of any federally funded contract, making any federally funded grant or loan, entering into any cooperative agreement, or to extend, continue, renew, amend, or modify any federally funded contract, grant, loan, or cooperative agreement.

3. The Disclosing Party will submit an updated certification at the end of each calendar quarter in which there occurs any event that materially affects the accuracy of the statements and information set forth in paragraphs A(1) and A(2) above.

4. The Disclosing Party certifies that either: (i) it is not an organization described in section 501(c)(4) of the Internal Revenue Code of 1986; or (ii) it is an organization described in section 501(c)(4) of the Internal Revenue Code of 1986 but has not engaged and will not engage in "Lobbying Activities," as that term is defined in the Lobbying Disclosure Act of 1995, as amended.

5. If the Disclosing Party is the Applicant, the Disclosing Party must obtain certifications equal in form and substance to paragraphs A(1) through A(4) above from all subcontractors before it awards any subcontract and the Disclosing Party must maintain all such subcontractors' certifications for the duration of the Matter and must make such certifications promptly available to the City upon request.

B. CERTIFICATION REGARDING EQUAL EMPLOYMENT OPPORTUNITY

If the Matter is federally funded, federal regulations require the Applicant and all proposed subcontractors to submit the following information with their bids or in writing at the outset of negotiations.

Is the Disclosing Party the Applicant?

Yes

No

If "Yes," answer the three questions below:

1. Have you developed and do you have on file affirmative action programs pursuant to applicable federal regulations? (See 41 CFR Part 60-2.)

Yes

No

2. Have you filed with the Joint Reporting Committee, the Director of the Office of Federal Contract Compliance Programs, or the Equal Employment Opportunity Commission all reports due under the applicable filing requirements?

Yes

No

Reports not required

3. Have you participated in any previous contracts or subcontracts subject to the equal opportunity clause?

Yes

No

If you checked "No" to question (1) or (2) above, please provide an explanation:

SECTION VII – FURTHER ACKNOWLEDGMENTS AND CERTIFICATION

The Disclosing Party understands and agrees that:

A. The certifications, disclosures, and acknowledgments contained in this EDS will become part of any contract or other agreement between the Applicant and the City in connection with the Matter, whether procurement, City assistance, or other City action, and are material inducements to the City's execution of any contract or taking other action with respect to the Matter. The Disclosing Party understands that it must comply with all statutes, ordinances, and regulations on which this EDS is based.

B. The City's Governmental Ethics Ordinance, MCC Chapter 2-156, imposes certain duties and obligations on persons or entities seeking City contracts, work, business, or transactions. The full text of this ordinance and a training program is available on line at www.cityofchicago.org/Ethics, and may also be obtained from the City's Board of Ethics, 740 N. Sedgwick St., Suite 500, Chicago, IL 60610, (312) 744-9660. The Disclosing Party must comply fully with this ordinance.

C. If the City determines that any information provided in this EDS is false, incomplete or inaccurate, any contract or other agreement in connection with which it is submitted may be rescinded or be void or voidable, and the City may pursue any remedies under the contract or agreement (if not rescinded or void), at law, or in equity, including terminating the Disclosing Party's participation in the Matter and/or declining to allow the Disclosing Party to participate in other City transactions. Remedies at law for a false statement of material fact may include incarceration and an award to the City of treble damages.

D. It is the City's policy to make this document available to the public on its Internet site and/or upon request. Some or all of the information provided in, and appended to, this EDS may be made publicly available on the Internet, in response to a Freedom of Information Act request, or otherwise. By completing and signing this EDS, the Disclosing Party waives and releases any possible rights or claims which it may have against the City in connection with the public release of information contained in this EDS and also authorizes the City to verify the accuracy of any information submitted in this EDS.

E. The information provided in this EDS must be kept current. In the event of changes, the Disclosing Party must supplement this EDS up to the time the City takes action on the Matter. If the Matter is a contract being handled by the City's Department of Procurement Services, the Disclosing Party must update this EDS as the contract requires. **NOTE:** With respect to Matters subject to MCC Chapter 1-23, Article I (imposing **PERMANENT INELIGIBILITY** for certain specified offenses), the information provided herein regarding eligibility must be kept current for a longer period, as required by MCC Chapter 1-23 and Section 2-154-020.

CERTIFICATION

Under penalty of perjury, the person signing below: (1) warrants that he/she is authorized to execute this EDS, and all applicable Appendices, on behalf of the Disclosing Party, and (2) warrants that all certifications and statements contained in this EDS, and all applicable Appendices, are true, accurate and complete as of the date furnished to the City.

NORTHWESTERN MEMORIAL HEALTHCARE

(Print or type exact legal name of Disclosing Party)

By: _____

(Sign here)

Gina Weldy

(Print or type name of person signing)

Senior Vice President, Administration

(Print or type title of person signing)

Signed and sworn to before me on (date) 3.17.22,

at Cook County, Illinois (state).

Endia Latham
Notary Public

Commission expires: 10.21.24

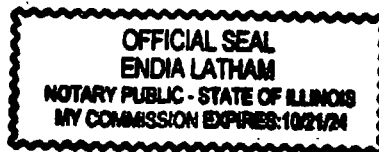

Thomas L. Hefty

Digitally signed by Thomas L. Hefty
DN: cn=Thomas L. Hefty, o=Northwestern Memorial
HealthCare, ou=Office of General Counsel,
email=thomas.hefty@nm.org, c=US
Reason: OGC reviewed and approved for final execution
Location: 211 E. Ontario St., Ste 1800, Chicago, IL 60611
Date: 2022.03.10 18:51:49 -0500

**CITY OF CHICAGO
ECONOMIC DISCLOSURE STATEMENT AND AFFIDAVIT
APPENDIX A**

**FAMILIAL RELATIONSHIPS WITH ELECTED CITY OFFICIALS
AND DEPARTMENT HEADS**

This Appendix is to be completed only by (a) the Applicant, and (b) any legal entity which has a direct ownership interest in the Applicant exceeding 7.5%. It is not to be completed by any legal entity which has only an indirect ownership interest in the Applicant.

Under MCC Section 2-154-015, the Disclosing Party must disclose whether such Disclosing Party or any "Applicable Party" or any Spouse or Domestic Partner thereof currently has a "familial relationship" with any elected city official or department head. A "familial relationship" exists if, as of the date this EDS is signed, the Disclosing Party or any "Applicable Party" or any Spouse or Domestic Partner thereof is related to the mayor, any alderman, the city clerk, the city treasurer or any city department head as spouse or domestic partner or as any of the following, whether by blood or adoption: parent, child, brother or sister, aunt or uncle, niece or nephew, grandparent, grandchild, father-in-law, mother-in-law, son-in-law, daughter-in-law, stepfather or stepmother, stepson or stepdaughter, stepbrother or stepsister or half-brother or half-sister.

"Applicable Party" means (1) all executive officers of the Disclosing Party listed in Section II.B.1.a., if the Disclosing Party is a corporation; all partners of the Disclosing Party, if the Disclosing Party is a general partnership; all general partners and limited partners of the Disclosing Party, if the Disclosing Party is a limited partnership; all managers, managing members and members of the Disclosing Party, if the Disclosing Party is a limited liability company; (2) all principal officers of the Disclosing Party; and (3) any person having more than a 7.5% ownership interest in the Disclosing Party. "Principal officers" means the president, chief operating officer, executive director, chief financial officer, treasurer or secretary of a legal entity or any person exercising similar authority.

Does the Disclosing Party or any "Applicable Party" or any Spouse or Domestic Partner thereof currently have a "familial relationship" with an elected city official or department head?

Yes

No

If yes, please identify below (1) the name and title of such person, (2) the name of the legal entity to which such person is connected; (3) the name and title of the elected city official or department head to whom such person has a familial relationship, and (4) the precise nature of such familial relationship.

**CITY OF CHICAGO
ECONOMIC DISCLOSURE STATEMENT AND AFFIDAVIT
APPENDIX B**

BUILDING CODE SCOFFLAW/PROBLEM LANDLORD CERTIFICATION

This Appendix is to be completed only by (a) the Applicant, and (b) any legal entity which has a direct ownership interest in the Applicant exceeding 7.5% (an "Owner"). It is not to be completed by any legal entity which has only an indirect ownership interest in the Applicant.

1. Pursuant to MCC Section 2-154-010, is the Applicant or any Owner identified as a building code scofflaw or problem landlord pursuant to MCC Section 2-92-416?

Yes No

2. If the Applicant is a legal entity publicly traded on any exchange, is any officer or director of the Applicant identified as a building code scofflaw or problem landlord pursuant to MCC Section 2-92-416?

Yes No The Applicant is not publicly traded on any exchange.

3. If yes to (1) or (2) above, please identify below the name of each person or legal entity identified as a building code scofflaw or problem landlord and the address of each building or buildings to which the pertinent code violations apply.

**CITY OF CHICAGO
ECONOMIC DISCLOSURE STATEMENT AND AFFIDAVIT
APPENDIX C**

PROHIBITION ON WAGE & SALARY HISTORY SCREENING - CERTIFICATION

This Appendix is to be completed only by an Applicant that is completing this EDS as a “contractor” as defined in MCC Section 2-92-385. That section, which should be consulted (www.amlegal.com), generally covers a party to any agreement pursuant to which they: (i) receive City of Chicago funds in consideration for services, work or goods provided (including for legal or other professional services), or (ii) pay the City money for a license, grant or concession allowing them to conduct a business on City premises.

On behalf of an Applicant that is a contractor pursuant to MCC Section 2-92-385, I hereby certify that the Applicant is in compliance with MCC Section 2-92-385(b)(1) and (2), which prohibit: (i) screening job applicants based on their wage or salary history, or (ii) seeking job applicants’ wage or salary history from current or former employers. I also certify that the Applicant has adopted a policy that includes those prohibitions.

Yes

No

N/A – I am not an Applicant that is a “contractor” as defined in MCC Section 2-92-385.

This certification shall serve as the affidavit required by MCC Section 2-92-385(c)(1).

If you checked “no” to the above, please explain.

Schedule 1

NORTHWESTERN MEMORIAL HEALTHCARE	
<u>Directors</u> Carol L. Bernick John A. Canning, Chair Nicholas D. Chabraja Kent P. Dauten Manny Favela William P. Flesch, Vice Chair Dean M. Harrison, NMHC President & CEO Lawrence K. Hunt Michael J. Kachmer Joseph D. Mansueto Timothy P. Moen Eric G. Neilson, MD, FSM Dean William A. Osborn, Vice Chair J. Christopher Reyes, Vice Chair Timothy P. Sullivan Morton O. Schapiro, NU President Donald L. Thompson Douglas E. Vaughan, MD Patricia A. Woertz Charie A. Zanck	<u>Officers</u> John A. Canning, Chair William P. Flesch, Vice Chair William A. Osborn, Vice Chair J. Christopher Reyes, Vice Chair Dean M. Harrison, President and CEO John A. Orsini, Treasurer Susan A. Ratzler, Assistant Treasurer Danae K. Prousis, Secretary Emily J. Kozak, Assistant Secretary

THERE ARE NO MEMBERS WHO ARE LEGAL ENTITIES

ECONOMIC DISCLOSURE STATEMENT -- SCHEDULE 2
[SECTION IV -- DISCLOSURE OF SUBCONTRACTORS AND OTHER RETAINED PARTIES]

<i>Name (all parties below have been retained by applicant).</i>	Address	Business Relationship to Disclosing Party(indicate whether subcontractor, attorney lobbyist, etc.)	Fees(paid or estimated.) NOTE: "hourly rate" or "t.b.d." is not an acceptable response
LEROY & NEAL, LLC	20 S. Clark Street Suite 2050 Chicago, IL 60603	Zoning Attorney	\$30,000 (est.)
V3	7325 Janes Avenue Woodridge, IL 60517	Surveyor	\$10,000 (est.)
Gensler	11 East Madison Street, Suite 300 Chicago, Illinois 60602	Design Consultant	\$65,000 (est.)

(DO NOT SUBMIT THIS PAGE WITH YOUR EDS. The purpose of this page is for you to recertify your EDS prior to submission to City Council or on the date of closing. If unable to recertify truthfully, the Disclosing Party must complete a new EDS with correct or corrected information)

RECERTIFICATION

Generally, for use with City Council matters. Not for City procurements unless requested.

This recertification is being submitted in connection with Planned Development application for 633 N. St. Clair St. [identify the Matter]. Under penalty of perjury, the person signing below: (1) warrants that he/she is authorized to execute this EDS recertification on behalf of the Disclosing Party, (2) warrants that all certifications and statements contained in the Disclosing Party's original EDS are true, accurate and complete as of the date furnished to the City and continue to be true, accurate and complete as of the date of this recertification, and (3) reaffirms its acknowledgments.

American College of Surgeons
(Print or type legal name of Disclosing Party)

Date: 9/29/2022

By:

Gay Vincent
(sign here)

Print or type name of signatory:

Gay L. Vincent, CPA, MBA
Chief Financial Officer
Title of signatory:

Signed and sworn to before me on [date] September 29, 2022, by
Gay Vincent, at Cook County, Illinois [state].

Marshall Smith Notary Public.

Commission expires: 2/10/2024.

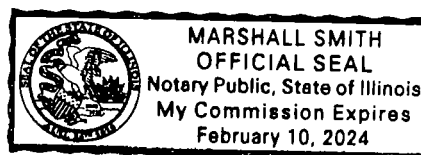

**CITY OF CHICAGO
ECONOMIC DISCLOSURE STATEMENT
AND AFFIDAVIT
SECTION I -- GENERAL INFORMATION**

A. Legal name of the Disclosing Party submitting this EDS. Include d/b/a/ if applicable:

AMERICAN COLLEGE OF SURGEONS

Check ONE of the following three boxes: *Additional box #4 has been added to identify Ownership Disclosing Party (not Applicant) of Property included in PD Application

Indicate whether the Disclosing Party submitting this EDS is:

1. the Applicant
OR

2. a legal entity currently holding, or anticipated to hold within six months after City action on the contract, transaction or other undertaking to which this EDS pertains (referred to below as the "Matter"), a direct or indirect interest in excess of 7.5% in the Applicant. State the Applicant's legal name: _____

OR

3. a legal entity with a direct or indirect right of control of the Applicant (see Section II(B)(1)) State the legal name of the entity in which the Disclosing Party holds a right of control: _____

4. a legal entity with a direct or indirect right of control of the Owner:

Chicago Title Land Trust Co., T/U/T/A dtd February 1, 1996, #121309-2, Owner of the
Property that is the subject of the Matter. Applicant: Northwestern Memorial Healthcare

B. Business address of the Disclosing Party: 633 N. St. Clair St.
Chicago, IL 60611

C. Telephone: 312-202-5449 Fax: 312-202-5025 Email: gvincent@facs.org

D. Name of contact person: Gay Vincent

E. Federal Employer Identification No. (if you have one): _____

F. Brief description of the Matter to which this EDS pertains. (Include project number and location of property, if applicable):

Planned Development application for 633 N. St. Clair Street.

G. Which City agency or department is requesting this EDS? Planning and Development

If the Matter is a contract being handled by the City's Department of Procurement Services, please complete the following:

Specification # _____ and Contract # _____

SECTION II -- DISCLOSURE OF OWNERSHIP INTERESTS

A. NATURE OF THE DISCLOSING PARTY

1. Indicate the nature of the Disclosing Party:

- | | |
|---|---|
| <input type="checkbox"/> Person | <input type="checkbox"/> Limited liability company |
| <input type="checkbox"/> Publicly registered business corporation | <input type="checkbox"/> Limited liability partnership |
| <input type="checkbox"/> Privately held business corporation | <input type="checkbox"/> Joint venture |
| <input type="checkbox"/> Sole proprietorship | <input checked="" type="checkbox"/> Not-for-profit corporation |
| <input type="checkbox"/> General partnership | (Is the not-for-profit corporation also a 501(c)(3))? |
| <input type="checkbox"/> Limited partnership | <input checked="" type="checkbox"/> Yes <input type="checkbox"/> No |
| <input type="checkbox"/> Trust | <input type="checkbox"/> Other (please specify) |
-

2. For legal entities, the state (or foreign country) of incorporation or organization, if applicable:

Illinois

3. For legal entities not organized in the State of Illinois: Has the organization registered to do business in the State of Illinois as a foreign entity?

- Yes No Organized in Illinois

B. IF THE DISCLOSING PARTY IS A LEGAL ENTITY:

1. List below the full names and titles, if applicable, of: (i) all executive officers and all directors of the entity; (ii) **for not-for-profit corporations**, all members, if any, which are legal entities (if there are no such members, write "no members which are legal entities"); (iii) **for trusts, estates or other similar entities**, the trustee, executor, administrator, or similarly situated party; (iv) **for general or limited partnerships, limited liability companies, limited liability partnerships or joint ventures**, each general partner, managing member, manager or any other person or legal entity that directly or indirectly controls the day-to-day management of the Applicant.

NOTE: Each legal entity listed below must submit an EDS on its own behalf.

Name	Title
------	-------

No members which are legal entities.

2. Please provide the following information concerning each person or legal entity having a direct or indirect, current or prospective (i.e. within 6 months after City action) beneficial interest (including ownership) in excess of 7.5% of the Applicant. Examples of such an interest include shares in a corporation, partnership interest in a partnership or joint venture, interest of a member or manager in a

limited liability company, or interest of a beneficiary of a trust, estate or other similar entity. If none, state "None."

NOTE: Each legal entity listed below may be required to submit an EDS on its own behalf.

Name None	Business Address	Percentage Interest in the Applicant

SECTION III -- INCOME OR COMPENSATION TO, OR OWNERSHIP BY, CITY ELECTED OFFICIALS

Has the Disclosing Party provided any income or compensation to any City elected official during the 12-month period preceding the date of this EDS? Yes No

Does the Disclosing Party reasonably expect to provide any income or compensation to any City elected official during the 12-month period following the date of this EDS? Yes No

If "yes" to either of the above, please identify below the name(s) of such City elected official(s) and describe such income or compensation:

Does any City elected official or, to the best of the Disclosing Party's knowledge after reasonable inquiry, any City elected official's spouse or domestic partner, have a financial interest (as defined in Chapter 2-156 of the Municipal Code of Chicago ("MCC")) in the Disclosing Party?

Yes No

If "yes," please identify below the name(s) of such City elected official(s) and/or spouse(s)/domestic partner(s) and describe the financial interest(s).

SECTION IV -- DISCLOSURE OF SUBCONTRACTORS AND OTHER RETAINED PARTIES

The Disclosing Party must disclose the name and business address of each subcontractor, attorney, lobbyist (as defined in MCC Chapter 2-156), accountant, consultant and any other person or entity whom the Disclosing Party has retained or expects to retain in connection with the Matter, as well as the nature of the relationship, and the total amount of the fees paid or estimated to be paid. The Disclosing Party is not required to disclose employees who are paid solely through the Disclosing Party's regular payroll. If the Disclosing Party is uncertain whether a disclosure is required under this Section, the Disclosing Party must either ask the City whether disclosure is required or make the disclosure.

Name (indicate whether retained or anticipated to be retained)	Business Address	Relationship to Disclosing Party (subcontractor, attorney, lobbyist, etc.)	Fees (<u>indicate whether paid or estimated.</u>) NOTE: "hourly rate" or "t.b.d." is not an acceptable response.
--	------------------	--	---

None

(Add sheets if necessary)

Check here if the Disclosing Party has not retained, nor expects to retain, any such persons or entities.

SECTION V -- CERTIFICATIONS

A. COURT-ORDERED CHILD SUPPORT COMPLIANCE

Under MCC Section 2-92-415, substantial owners of business entities that contract with the City must remain in compliance with their child support obligations throughout the contract's term.

Has any person who directly or indirectly owns 10% or more of the Disclosing Party been declared in arrearage on any child support obligations by any Illinois court of competent jurisdiction?

Yes No No person directly or indirectly owns 10% or more of the Disclosing Party.

If "Yes," has the person entered into a court-approved agreement for payment of all support owed and is the person in compliance with that agreement?

Yes No

B. FURTHER CERTIFICATIONS

1. [This paragraph 1 applies only if the Matter is a contract being handled by the City's Department of Procurement Services.] In the 5-year period preceding the date of this EDS, neither the Disclosing Party nor any Affiliated Entity [see definition in (5) below] has engaged, in connection with the performance of any public contract, the services of an integrity monitor, independent private sector inspector general, or integrity compliance consultant (i.e., an individual or entity with legal, auditing, investigative, or other similar skills, designated by a public agency to help the agency monitor the activity of specified agency vendors as well as help the vendors reform their business practices so they can be considered for agency contracts in the future, or continue with a contract in progress).

2. The Disclosing Party and its Affiliated Entities are not delinquent in the payment of any fine, fee, tax or other source of indebtedness owed to the City of Chicago, including, but not limited to, water and sewer charges, license fees, parking tickets, property taxes and sales taxes, nor is the Disclosing Party delinquent in the payment of any tax administered by the Illinois Department of Revenue.

3. The Disclosing Party and, if the Disclosing Party is a legal entity, all of those persons or entities identified in Section II(B)(1) of this EDS:

- a. are not presently debarred, suspended, proposed for debarment, declared ineligible or voluntarily excluded from any transactions by any federal, state or local unit of government;
- b. have not, during the 5 years before the date of this EDS, been convicted of a criminal offense, adjudged guilty, or had a civil judgment rendered against them in connection with: obtaining, attempting to obtain, or performing a public (federal, state or local) transaction or contract under a public transaction; a violation of federal or state antitrust statutes; fraud; embezzlement; theft; forgery; bribery; falsification or destruction of records; making false statements; or receiving stolen property;
- c. are not presently indicted for, or criminally or civilly charged by, a governmental entity (federal, state or local) with committing any of the offenses set forth in subparagraph (b) above;
- d. have not, during the 5 years before the date of this EDS, had one or more public transactions (federal, state or local) terminated for cause or default; and
- e. have not, during the 5 years before the date of this EDS, been convicted, adjudged guilty, or found liable in a civil proceeding, or in any criminal or civil action, including actions concerning environmental violations, instituted by the City or by the federal government, any state, or any other unit of local government.

4. The Disclosing Party understands and shall comply with the applicable requirements of MCC Chapters 2-56 (Inspector General) and 2-156 (Governmental Ethics).

5. Certifications (5), (6) and (7) concern:

- the Disclosing Party;
- any "Contractor" (meaning any contractor or subcontractor used by the Disclosing Party in connection with the Matter, including but not limited to all persons or legal entities disclosed under Section IV, "Disclosure of Subcontractors and Other Retained Parties");
- any "Affiliated Entity" (meaning a person or entity that, directly or indirectly: controls the Disclosing Party, is controlled by the Disclosing Party, or is, with the Disclosing Party, under common control of another person or entity). Indicia of control include, without limitation: interlocking management or ownership; identity of interests among family members, shared facilities and equipment; common use of employees; or organization of a business entity following the ineligibility of a business entity to do business with federal or state or local government, including the City, using substantially the same management, ownership, or principals as the ineligible entity. With respect to Contractors, the term Affiliated Entity means a person or entity that directly or indirectly controls the Contractor, is controlled by it, or, with the Contractor, is under common control of another person or entity;
- any responsible official of the Disclosing Party, any Contractor or any Affiliated Entity or any other official, agent or employee of the Disclosing Party, any Contractor or any Affiliated Entity, acting pursuant to the direction or authorization of a responsible official of the Disclosing Party, any Contractor or any Affiliated Entity (collectively "Agents").

Neither the Disclosing Party, nor any Contractor, nor any Affiliated Entity of either the Disclosing Party or any Contractor, nor any Agents have, during the 5 years before the date of this EDS, or, with respect to a Contractor, an Affiliated Entity, or an Affiliated Entity of a Contractor during the 5 years before the date of such Contractor's or Affiliated Entity's contract or engagement in connection with the Matter:

- a. bribed or attempted to bribe, or been convicted or adjudged guilty of bribery or attempting to bribe, a public officer or employee of the City, the State of Illinois, or any agency of the federal government or of any state or local government in the United States of America, in that officer's or employee's official capacity;
 - b. agreed or colluded with other bidders or prospective bidders, or been a party to any such agreement, or been convicted or adjudged guilty of agreement or collusion among bidders or prospective bidders, in restraint of freedom of competition by agreement to bid a fixed price or otherwise; or
 - c. made an admission of such conduct described in subparagraph (a) or (b) above that is a matter of record, but have not been prosecuted for such conduct; or
 - d. violated the provisions referenced in MCC Subsection 2-92-320(a)(4)(Contracts Requiring a Base Wage); (a)(5)(Debarment Regulations); or (a)(6)(Minimum Wage Ordinance).
6. Neither the Disclosing Party, nor any Affiliated Entity or Contractor, or any of their employees, officials, agents or partners, is barred from contracting with any unit of state or local government as a result of engaging in or being convicted of (1) bid-rigging in violation of 720 ILCS 5/33E-3; (2) bid-rotating in violation of 720 ILCS 5/33E-4; or (3) any similar offense of any state or of the United States of America that contains the same elements as the offense of bid-rigging or bid-rotating.
7. Neither the Disclosing Party nor any Affiliated Entity is listed on a Sanctions List maintained by the United States Department of Commerce, State, or Treasury, or any successor federal agency.
8. [FOR APPLICANT ONLY] (i) Neither the Applicant nor any "controlling person" [see MCC Chapter 1-23, Article I for applicability and defined terms] of the Applicant is currently indicted or charged with, or has admitted guilt of, or has ever been convicted of, or placed under supervision for, any criminal offense involving actual, attempted, or conspiracy to commit bribery, theft, fraud, forgery, perjury, dishonesty or deceit against an officer or employee of the City or any "sister agency"; and (ii) the Applicant understands and acknowledges that compliance with Article I is a continuing requirement for doing business with the City. NOTE: If MCC Chapter 1-23, Article I applies to the Applicant, that Article's permanent compliance timeframe supersedes 5-year compliance timeframes in this Section V.
9. [FOR APPLICANT ONLY] The Applicant and its Affiliated Entities will not use, nor permit their subcontractors to use, any facility listed as having an active exclusion by the U.S. EPA on the federal System for Award Management ("SAM").
10. [FOR APPLICANT ONLY] The Applicant will obtain from any contractors/subcontractors hired or to be hired in connection with the Matter certifications equal in form and substance to those in Certifications (2) and (9) above and will not, without the prior written consent of the City, use any such

contractor/subcontractor that does not provide such certifications or that the Applicant has reason to believe has not provided or cannot provide truthful certifications.

11. If the Disclosing Party is unable to certify to any of the above statements in this Part B (Further Certifications), the Disclosing Party must explain below:

If the letters "NA," the word "None," or no response appears on the lines above, it will be conclusively presumed that the Disclosing Party certified to the above statements.

12. To the best of the Disclosing Party's knowledge after reasonable inquiry, the following is a complete list of all current employees of the Disclosing Party who were, at any time during the 12-month period preceding the date of this EDS, an employee, or elected or appointed official, of the City of Chicago (if none, indicate with "N/A" or "none").

None

13. To the best of the Disclosing Party's knowledge after reasonable inquiry, the following is a complete list of all gifts that the Disclosing Party has given or caused to be given, at any time during the 12-month period preceding the execution date of this EDS, to an employee, or elected or appointed official, of the City of Chicago. For purposes of this statement, a "gift" does not include: (i) anything made generally available to City employees or to the general public, or (ii) food or drink provided in the course of official City business and having a retail value of less than \$25 per recipient, or (iii) a political contribution otherwise duly reported as required by law (if none, indicate with "N/A" or "none"). As to any gift listed below, please also list the name of the City recipient.

None

C. CERTIFICATION OF STATUS AS FINANCIAL INSTITUTION

1. The Disclosing Party certifies that the Disclosing Party (check one)

is is not

a "financial institution" as defined in MCC Section 2-32-455(b).

2. If the Disclosing Party IS a financial institution, then the Disclosing Party pledges:

"We are not and will not become a predatory lender as defined in MCC Chapter 2-32. We further pledge that none of our affiliates is, and none of them will become, a predatory lender as defined in MCC Chapter 2-32. We understand that becoming a predatory lender or becoming an affiliate of a predatory lender may result in the loss of the privilege of doing business with the City."

If the Disclosing Party is unable to make this pledge because it or any of its affiliates (as defined in MCC Section 2-32-455(b)) is a predatory lender within the meaning of MCC Chapter 2-32, explain here (attach additional pages if necessary):

None

If the letters "NA," the word "None," or no response appears on the lines above, it will be conclusively presumed that the Disclosing Party certified to the above statements.

D. CERTIFICATION REGARDING FINANCIAL INTEREST IN CITY BUSINESS

Any words or terms defined in MCC Chapter 2-156 have the same meanings if used in this Part D.

1. In accordance with MCC Section 2-156-110: To the best of the Disclosing Party's knowledge after reasonable inquiry, does any official or employee of the City have a financial interest in his or her own name or in the name of any other person or entity in the Matter?

Yes

No

NOTE: If you checked "Yes" to Item D(1), proceed to Items D(2) and D(3). If you checked "No" to Item D(1), skip Items D(2) and D(3) and proceed to Part E.

2. Unless sold pursuant to a process of competitive bidding, or otherwise permitted, no City elected official or employee shall have a financial interest in his or her own name or in the name of any other person or entity in the purchase of any property that (i) belongs to the City, or (ii) is sold for taxes or assessments, or (iii) is sold by virtue of legal process at the suit of the City (collectively, "City Property Sale"). Compensation for property taken pursuant to the City's eminent domain power does not constitute a financial interest within the meaning of this Part D.

Does the Matter involve a City Property Sale?

Yes

No

3. If you checked "Yes" to Item D(1), provide the names and business addresses of the City officials or employees having such financial interest and identify the nature of the financial interest:

Name	Business Address	Nature of Financial Interest
<hr/>		
<hr/>		
<hr/>		

4. The Disclosing Party further certifies that no prohibited financial interest in the Matter will be acquired by any City official or employee.

E. CERTIFICATION REGARDING SLAVERY ERA BUSINESS

Please check either (1) or (2) below. If the Disclosing Party checks (2), the Disclosing Party must disclose below or in an attachment to this EDS all information required by (2). Failure to comply with these disclosure requirements may make any contract entered into with the City in connection with the Matter voidable by the City.

1. The Disclosing Party verifies that the Disclosing Party has searched any and all records of the Disclosing Party and any and all predecessor entities regarding records of investments or profits from slavery or slaveholder insurance policies during the slavery era (including insurance policies issued to slaveholders that provided coverage for damage to or injury or death of their slaves), and the Disclosing Party has found no such records.

2. The Disclosing Party verifies that, as a result of conducting the search in step (1) above, the Disclosing Party has found records of investments or profits from slavery or slaveholder insurance policies. The Disclosing Party verifies that the following constitutes full disclosure of all such records, including the names of any and all slaves or slaveholders described in those records:

SECTION VI -- CERTIFICATIONS FOR FEDERALLY FUNDED MATTERS

NOTE: If the Matter is federally funded, complete this Section VI. If the Matter is not federally funded, proceed to Section VII. For purposes of this Section VI, tax credits allocated by the City and proceeds of debt obligations of the City are not federal funding.

A. CERTIFICATION REGARDING LOBBYING

1. List below the names of all persons or entities registered under the federal Lobbying Disclosure Act of 1995, as amended, who have made lobbying contacts on behalf of the Disclosing Party with respect to the Matter: (Add sheets if necessary):

(If no explanation appears or begins on the lines above, or if the letters "NA" or if the word "None" appear, it will be conclusively presumed that the Disclosing Party means that NO persons or entities registered under the Lobbying Disclosure Act of 1995, as amended, have made lobbying contacts on behalf of the Disclosing Party with respect to the Matter.)

2. The Disclosing Party has not spent and will not expend any federally appropriated funds to pay any person or entity listed in paragraph A(1) above for his or her lobbying activities or to pay any person or entity to influence or attempt to influence an officer or employee of any agency, as defined by applicable federal law, a member of Congress, an officer or employee of Congress, or an employee

of a member of Congress, in connection with the award of any federally funded contract, making any federally funded grant or loan, entering into any cooperative agreement, or to extend, continue, renew, amend, or modify any federally funded contract, grant, loan, or cooperative agreement.

3. The Disclosing Party will submit an updated certification at the end of each calendar quarter in which there occurs any event that materially affects the accuracy of the statements and information set forth in paragraphs A(1) and A(2) above.

4. The Disclosing Party certifies that either: (i) it is not an organization described in section 501(c)(4) of the Internal Revenue Code of 1986; or (ii) it is an organization described in section 501(c)(4) of the Internal Revenue Code of 1986 but has not engaged and will not engage in "Lobbying Activities," as that term is defined in the Lobbying Disclosure Act of 1995, as amended.

5. If the Disclosing Party is the Applicant, the Disclosing Party must obtain certifications equal in form and substance to paragraphs A(1) through A(4) above from all subcontractors before it awards any subcontract and the Disclosing Party must maintain all such subcontractors' certifications for the duration of the Matter and must make such certifications promptly available to the City upon request.

B. CERTIFICATION REGARDING EQUAL EMPLOYMENT OPPORTUNITY

If the Matter is federally funded, federal regulations require the Applicant and all proposed subcontractors to submit the following information with their bids or in writing at the outset of negotiations.

Is the Disclosing Party the Applicant?

Yes

No

If "Yes," answer the three questions below:

1. Have you developed and do you have on file affirmative action programs pursuant to applicable federal regulations? (See 41 CFR Part 60-2.)

Yes

No

2. Have you filed with the Joint Reporting Committee, the Director of the Office of Federal Contract Compliance Programs, or the Equal Employment Opportunity Commission all reports due under the applicable filing requirements?

Yes

No

Reports not required

3. Have you participated in any previous contracts or subcontracts subject to the equal opportunity clause?

Yes

No

If you checked "No" to question (1) or (2) above, please provide an explanation:

SECTION VII -- FURTHER ACKNOWLEDGMENTS AND CERTIFICATION

The Disclosing Party understands and agrees that:

A. The certifications, disclosures, and acknowledgments contained in this EDS will become part of any contract or other agreement between the Applicant and the City in connection with the Matter, whether procurement, City assistance, or other City action, and are material inducements to the City's execution of any contract or taking other action with respect to the Matter. The Disclosing Party understands that it must comply with all statutes, ordinances, and regulations on which this EDS is based.

B. The City's Governmental Ethics Ordinance, MCC Chapter 2-156, imposes certain duties and obligations on persons or entities seeking City contracts, work, business, or transactions. The full text of this ordinance and a training program is available on line at www.cityofchicago.org/Ethics, and may also be obtained from the City's Board of Ethics, 740 N. Sedgwick St., Suite 500, Chicago, IL 60610, (312) 744-9660. The Disclosing Party must comply fully with this ordinance.

C. If the City determines that any information provided in this EDS is false, incomplete or inaccurate, any contract or other agreement in connection with which it is submitted may be rescinded or be void or voidable, and the City may pursue any remedies under the contract or agreement (if not rescinded or void), at law, or in equity, including terminating the Disclosing Party's participation in the Matter and/or declining to allow the Disclosing Party to participate in other City transactions. Remedies at law for a false statement of material fact may include incarceration and an award to the City of treble damages.

D. It is the City's policy to make this document available to the public on its Internet site and/or upon request. Some or all of the information provided in, and appended to, this EDS may be made publicly available on the Internet, in response to a Freedom of Information Act request, or otherwise. By completing and signing this EDS, the Disclosing Party waives and releases any possible rights or claims which it may have against the City in connection with the public release of information contained in this EDS and also authorizes the City to verify the accuracy of any information submitted in this EDS.

E. The information provided in this EDS must be kept current. In the event of changes, the Disclosing Party must supplement this EDS up to the time the City takes action on the Matter. If the Matter is a contract being handled by the City's Department of Procurement Services, the Disclosing Party must update this EDS as the contract requires. **NOTE:** With respect to Matters subject to MCC Chapter 1-23, Article I (imposing **PERMANENT INELIGIBILITY** for certain specified offenses), the information provided herein regarding eligibility must be kept current for a longer period, as required by MCC Chapter 1-23 and Section 2-154-020.

CERTIFICATION

Under penalty of perjury, the person signing below: (1) warrants that he/she is authorized to execute this EDS, and all applicable Appendices, on behalf of the Disclosing Party, and (2) warrants that all certifications and statements contained in this EDS, and all applicable Appendices, are true, accurate and complete as of the date furnished to the City.

American College of Surgeons

(Print or type exact legal name of Disclosing Party)

By: Gay Vincent
(Sign here)

Gay Vincent

(Print or type name of person signing)

Chief Financial Officer

(Print or type title of person signing)

Signed and sworn to before me on (date) 2/23/2022,

at Cook County, Illinois (state).

Marshall Smith

Notary Public

Commission expires: February 10, 2024

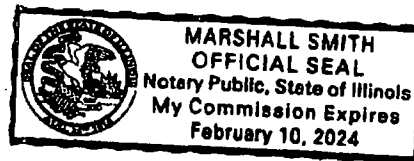

908264

**CITY OF CHICAGO
ECONOMIC DISCLOSURE STATEMENT AND AFFIDAVIT
APPENDIX A**

**FAMILIAL RELATIONSHIPS WITH ELECTED CITY OFFICIALS
AND DEPARTMENT HEADS**

This Appendix is to be completed only by (a) the Applicant, and (b) any legal entity which has a direct ownership interest in the Applicant exceeding 7.5%. It is not to be completed by any legal entity which has only an indirect ownership interest in the Applicant.

Under MCC Section 2-154-015, the Disclosing Party must disclose whether such Disclosing Party or any "Applicable Party" or any Spouse or Domestic Partner thereof currently has a "familial relationship" with any elected city official or department head. A "familial relationship" exists if, as of the date this EDS is signed, the Disclosing Party or any "Applicable Party" or any Spouse or Domestic Partner thereof is related to the mayor, any alderman, the city clerk, the city treasurer or any city department head as spouse or domestic partner or as any of the following, whether by blood or adoption: parent, child, brother or sister, aunt or uncle, niece or nephew, grandparent, grandchild, father-in-law, mother-in-law, son-in-law, daughter-in-law, stepfather or stepmother, stepson or stepdaughter, stepbrother or stepsister or half-brother or half-sister.

"Applicable Party" means (1) all executive officers of the Disclosing Party listed in Section II.B.1.a., if the Disclosing Party is a corporation; all partners of the Disclosing Party, if the Disclosing Party is a general partnership; all general partners and limited partners of the Disclosing Party, if the Disclosing Party is a limited partnership; all managers, managing members and members of the Disclosing Party, if the Disclosing Party is a limited liability company; (2) all principal officers of the Disclosing Party; and (3) any person having more than a 7.5% ownership interest in the Disclosing Party. "Principal officers" means the president, chief operating officer, executive director, chief financial officer, treasurer or secretary of a legal entity or any person exercising similar authority.

Does the Disclosing Party or any "Applicable Party" or any Spouse or Domestic Partner thereof currently have a "familial relationship" with an elected city official or department head?

Yes

No

If yes, please identify below (1) the name and title of such person, (2) the name of the legal entity to which such person is connected; (3) the name and title of the elected city official or department head to whom such person has a familial relationship, and (4) the precise nature of such familial relationship.

**CITY OF CHICAGO
ECONOMIC DISCLOSURE STATEMENT AND AFFIDAVIT
APPENDIX B**

BUILDING CODE SCOFFLAW/PROBLEM LANDLORD CERTIFICATION

This Appendix is to be completed only by (a) the Applicant, and (b) any legal entity which has a direct ownership interest in the Applicant exceeding 7.5% (an "Owner"). It is not to be completed by any legal entity which has only an indirect ownership interest in the Applicant.

1. Pursuant to MCC Section 2-154-010, is the Applicant or any Owner identified as a building code scofflaw or problem landlord pursuant to MCC Section 2-92-416?

Yes

No

2. If the Applicant is a legal entity publicly traded on any exchange, is any officer or director of the Applicant identified as a building code scofflaw or problem landlord pursuant to MCC Section 2-92-416?

Yes

No

The Applicant is not publicly traded on any exchange.

3. If yes to (1) or (2) above, please identify below the name of each person or legal entity identified as a building code scofflaw or problem landlord and the address of each building or buildings to which the pertinent code violations apply.

**CITY OF CHICAGO
ECONOMIC DISCLOSURE STATEMENT AND AFFIDAVIT
APPENDIX C**

PROHIBITION ON WAGE & SALARY HISTORY SCREENING - CERTIFICATION

This Appendix is to be completed only by an Applicant that is completing this EDS as a “contractor” as defined in MCC Section 2-92-385. That section, which should be consulted (www.amlegal.com), generally covers a party to any agreement pursuant to which they: (i) receive City of Chicago funds in consideration for services, work or goods provided (including for legal or other professional services), or (ii) pay the City money for a license, grant or concession allowing them to conduct a business on City premises.

On behalf of an Applicant that is a contractor pursuant to MCC Section 2-92-385, I hereby certify that the Applicant is in compliance with MCC Section 2-92-385(b)(1) and (2), which prohibit: (i) screening job applicants based on their wage or salary history, or (ii) seeking job applicants’ wage or salary history from current or former employers. I also certify that the Applicant has adopted a policy that includes those prohibitions.

Yes

No

N/A – I am not an Applicant that is a “contractor” as defined in MCC Section 2-92-385.

This certification shall serve as the affidavit required by MCC Section 2-92-385(c)(1).

If you checked “no” to the above, please explain.

AMERICAN COLLEGE OF SURGEONS

OFFICIALS OF THE COLLEGE FOR THE YEAR 2021-2022

November 1, 2021

OFFICERS

*Julie Ann Freischlag, **President**, Wake Forest Baptist Medical Center, Office of the Chief Executive Officer, Medical Center Boulevard, 10 Janeway Tower, Winston Salem, NC 27157-0001
Quan-Yang Duh, **First Vice President**, UCSF Mount Zion, 1600 Divisadero Street, San Francisco, CA 94115
Richard A. Lynn, **Second Vice President**, 165 Brazilian Avenue, Palm Beach, FL 33480-4221
J. Wayne Meredith, **Immediate Past President**, Wake Forest Baptist Medical Center, Chief of Surgery Department of Surgery, 5th FL Watlington Hall, Medical Center Boulevard, Winston Salem, NC 27157-0001
Tyler G. Hughes, **Secretary**, 138 N Santa Fe Ave, Salina, KS 67401-2616
Don K. Nakayama, **Treasurer**, University of North Carolina at Chapel Hill, 170 Manning Drive, C.B. 7223 Chapel Hill, NC 27599-7223
Patricia L. Turner **Director**, American College of Surgeons, 633 N Saint Clair St, Chicago, IL 60611-3211
Gay Vincent, **Chief Financial Officer**, American College of Surgeons, 633 N Saint Clair St, Chicago, IL 60611-3211

OFFICERS ELECT (Take Office October 2022)

E. Christopher Ellison, **President-Elect**, The Ohio State University, Dept. of Surgery, 395 W. 12th Avenue, Columbus, OH 43210
Mary E. Fallat, **First Vice President-Elect**, 315 E. Broadway, Ste 565, Louisville, KY 40202-3702
Anne G. Rizzo, **Second Vice President-Elect**, Robert Packer Hospital, 1 Guthrie Square, Sayre, PA 18840

BOARD OF REGENTS (* = Executive Committee)

*Anton N. Sidawy, **Chair**, Professor and Chairman, Department of Surgery, George Washington University MFA, 2150 Pennsylvania Avenue NW, Washington, DC 20037
*Linda G. Phillips, **Vice Chair**, Univ. of Texas Medical Branch, 6124 McCullough Building, 301 University Boulevard, Galveston, TX 77555-0724
*Anthony Atala, **Chair**, Wake Forest School of Medicine, Department of Urology, Medical Center Boulevard, Winston-Salem, NC 27157
Carol L. Brown, Memorial Sloan Kettering Cancer Center, 1233 York Avenue, SR505, New York, NY 10065-6007
Francoise P. Chagnon, 999 Boulevard de Maisonneuve West, Suite 1750, Montreal, QC, H3A 3L4, Canada
Annesley (AJ) W. Copeland, Department of Surgery, USUHS, 4301 Jones Bridge Road, Bethesda, MD 20814
James C. Denny III, AAO-HNS, 1650 Diagonal Road, Alexandria, VA 22314
Timothy J. Eberlein, Washington Univ. School of Medicine, 660 South Euclid Avenue, Box 8109, Saint Louis, MO 63110-1110
Diana L. Farmer, UC Davis Health System, Department of Surgery, North Addition Building, #6021, 2335 Stockton Boulevard Sacramento, CA 95817
James W. Fleshman, Jr., Baylor University Medical Center, Dept. of Surgery, 3500 Gaston Avenue, 2nd fl. Pickens Hospital, c2.311, Dallas, TX 75246-2017
James W. Gigantelli, Marshall University, Chair and Prof. of Ophthalmology, Marshall Eye Surgeons, East Hills Professional Center, 5187 US Route 60 East, Suite 6, Huntington, WV 25705
Sean C. Grondin, Foothills Medical Centre, 1403 29th Street NW, Room G 33D, Calgary, AB, T2N 2T9, Canada
Andrea Hayes, Howard University Hospital, 2041 Georgia Ave NW, Rm 4B-02, Washington DC, 20060
Fabrizio Michelassi, Weill Cornell Medical College, Dept. of Surgery, 525 East 68th Street, Mailbox 129, New York, NY 10065
Lena M. Napolitano, 1500 E Medical Center Dr, Spc 5033, Room 1C340-UH Department of Surgery, Ann Arbor, MI 48109-5033
Mark T. Savarise, University of Utah, South Jordan Health Center, 5126 W. Daybreak Parkway, South Jordan, UT 84095
Kenneth W. Sharp, Vanderbilt University Medical Center, D5203 MCN, Department of Surgery, 21st and Garland Ave., Nashville, TN 37232-0001
Steven C. Stain, Lahey Hospital and Medical Center, 41 Mall Rd., Burlington, MA 01805
Gary L. Timmerman, Surgical Associates, 1508 W 22nd Street, Ste 101, Sioux Falls, SD 57105-1514
Shelly D. Timmons, Dept. of Neurological Surgery, 355 W. 16th Str., Ste 5100, Indianapolis, IN 46202-2274
David J. Welsh, 222 State Road, 129 S, Batesville, IN 47006-7694
Philip R. Wolinsky, UC Davis Medical Center, Dept., of Orthopaedic Surgery, 5860 Y Str., Ste 3800, Sacramento, CA 95817-2307
Douglas E. Wood, University of Washington Medicine, Box 356410, 1959 NE Pacific Street, Bb 487D, Seattle, WA 98195-6410

EXECUTIVE COMMITTEE, BOARD OF GOVERNORS

Danielle Saunders Walsh, **Chair**, 2120 E. Fire Tower Rd, Suite 107-199, Greenville, NC 27858

Ross F. Goldberg, **Vice Chair**, 2601 E. Roosevelt Street, Valleywise Health Medical Center, Hogan Bldg, Dept. of Surgery, Phoenix, AZ 85008-4973

Oscar Guillaumondegui, **Secretary**, 1211 21st Avenue, Ste 404, Nashville, TN 37212-2721

Cherisse D. Berry, NYU Langone, Medical Center, 550 First Ave., NBV 12 East 36th, New York, NY 10016

Shannon M. Foster, 65 Syracuse Drive, Reading, PA 19606-9538

Lillian S. Kao, 6431 Fannin Street, MSB 4264, Houston, TX 77030-1501

Deepak G. Nair, 600 N. Cattlemen Road, Ste. 220, Sarasota, FL 34232-6422

PAST PRESIDENTS

Kathryn D. Anderson, 7942 Natoma Street, Eastvale, CA 92880-3260

W. Gerald Austen, Massachusetts General Hospital - BUL 370A, 32 Fruit St, Boston, MA 02114-2698

Barbara L. Bass, George Washington School of Medicine & Health Sciences, Ross Hall, Suite 710, Washington DC 20037

L. D. Britt, Dept. of Surgery, Eastern Virginia Med. School, 825 Fairfax Ave, Ste 610, Norfolk, VA 23507-1912

John L. Cameron, Dept. of Surgery, Johns Hopkins Hosp., 600 N Wolfe St, Blalock 679, Baltimore, MD 21287

Edward M. Copeland III, Dept. of Surgery, Univ. of Florida College of Medicine, Box 100286, Gainesville, FL 32610-0286

A. Brent Eastman, PO Box 1248, Rancho Santa Fe, CA 92067

Gerald B. Healy, 194 Grove St, Wellesley, MA 02482

R. Scott Jones, PO Box 156, North Garden, VA 22959

Edward R. Laws, Dept. of Neurosurgery, Brigham and Women's Hosp., 75 Francis St, PBB3, Boston MA 02115-6110

Ronald V. Maier, 325 9th Avenue, Harborview Medical Center, Department of Surgery
Box 35-9796, Seattle, WA 98104-2420

LaMar S. McGinnis, Jr., 3747 Peachtree Rd. NE, Apt. #521, Atlanta, GA 30319

J. Wayne Meredith, Wake Forest Baptist Medical Center, Chief of Surgery Department of Surgery, 5th FL Watlington Hall,
Medical Center Boulevard, Winston Salem, NC 27157-0001

David G. Murray, 5 Quaker Hill Rd, Syracuse, NY 13224

Patricia J. Numann, 323 Highland Avenue, Syracuse, NY 13203

Carlos A. Pellegrini, 11901 NE 36th Place, Bellevue, WA 98005

Valerie W. Rusch, 1275 York Ave, Memorial Sloan-Kettering Cancer Center, Thoracic Surgery, Box 7 NY, NY 10065-6007

Richard R. Sabo, 2336 Trailcrest Dr, Bozeman, MT 59718

Courtney M. Townsend, Jr, Univ. of Texas Medical Branch, John Sealy Annex Suite 6.146, 301 University Blvd,
Galveston, TX 77555-0527

Andrew L. Warshaw, Massachusetts General Hospital, Bulfinch 370c, 55 Fruit St, Boston, MA 02114-2696

EXECUTIVE STAFF

Executive Director: Patricia Turner MD, MBA, FACS

Division of Advocacy and Health Policy: Patrick V. Bailey, MD, FACS, Medical Director

Frank G. Opelka, MD, FACS, Medical Director

Christian Shalgian, Director

American College of Surgeons Foundation: Shane Hollett, Executive Director

Division of Convention and Meetings: TBD

Division of Education: Ajit K. Sachdeva, MD, FRCSC, FACS, Director

Executive Services: Lynese Kelley, Leadership Operations, Director

Cie Armstead, Director of DEI&A

Finance and Facilities: Gay Vincent, CPA, Chief Financial Officer

Human Resources and Operations: Michelle McGovern, Director

Division of Information Technology: Brian Harper, Director

Division of Integrated Communications: Natalie Boden, Director Internal Integrated Communications

Brian Edwards, Chief, External Communications

Journal of the American College of Surgeons: Timothy J. Eberlein, MD, FACS, Editor-in-Chief

Division of Member Services: TBD

ACS Military Health Strategic Partnership: Peggy Knudson, MD, FACS, Medical Director

Operation Giving Back: Girma Tefera, MD, FACS, Medical Director

Division of Research & Optimal Patient Care: Clifford Ko, MD, FACS, Director

Cancer Programs: Heidi Nelson, MD, FACS, Medical Director

Trauma Programs: Ronald M. Stewart, MD, FACS, Medical Director

Avery Nathens, MD, FACS, Medical Director

Jean Clemency, Administrative Director

(DO NOT SUBMIT THIS PAGE WITH YOUR EDS. The purpose of this page is for you to recertify your EDS prior to submission to City Council or on the date of closing. If unable to recertify truthfully, the Disclosing Party must complete a new EDS with correct or corrected information)

RECERTIFICATION

Generally, for use with City Council matters. Not for City procurements unless requested.

This recertification is being submitted in connection with Planned Development application for 633 N. St. Clair St. [identify the Matter]. Under penalty of perjury, the person signing below: (1) warrants that he/she is authorized to execute this EDS recertification on behalf of the Disclosing Party, (2) warrants that all certifications and statements contained in the Disclosing Party's original EDS are true, accurate and complete as of the date furnished to the City and continue to be true, accurate and complete as of the date of this recertification, and (3) reaffirms its acknowledgments.

Chicago Title Land Trust Company, T/U/T/A
dtd February 1, 1996, known as Trust no. 121309-2

Date: 09/30/2022

(Print or type legal name of Disclosing Party)

By:

Rachel Hunt
(sign here)

Print or type name of signatory:

RACHEL HUNTING

Title of signatory:

ASSISTANT VICE PRESIDENT



This instrument is executed by the undersigned Land Trustee, not personally but solely as Trustee in the exercise of the power and authority conferred upon and vested in it as such Trustee. It is expressly understood and agreed that all the warranties, indemnities, representations, covenants, undertakings and agreements herein made on the part of the Trustee are undertaken by it solely in its capacity as Trustee and not personally. No personal liability or personal responsibility is assumed by or shall at any time be asserted or enforceable against the Trustee on account of any warranty, indemnity, representation, covenant, undertaking or agreement of the Trustee in this instrument.

Signed and sworn to before me on [date] 09/30/2022, by RACHEL HUNTING, at Cook County, Illinois [state].

Cherice Hoard Notary Public.

Commission expires: 02/10/2024.



**CITY OF CHICAGO
ECONOMIC DISCLOSURE STATEMENT
AND AFFIDAVIT**

SECTION I -- GENERAL INFORMATION

A. Legal name of the Disclosing Party submitting this EDS. Include d/b/a/ if applicable:

Chicago Title Land Trust Company, T/U/T/A dtd February 1, 1996 and known as Trust No. 121309-2

Check ONE of the following three boxes: *Additional box #4 has been added to identify Ownership Disclosing Party (not Applicant) of Property included in PD Application

Indicate whether the Disclosing Party submitting this EDS is:

1. the Applicant
OR

2. a legal entity currently holding, or anticipated to hold within six months after City action on the contract, transaction or other undertaking to which this EDS pertains (referred to below as the "Matter"), a direct or indirect interest in excess of 7.5% in the Applicant. State the Applicant's legal name: _____

OR

3. a legal entity with a direct or indirect right of control of the Applicant (see Section II(B)(1)) State the legal name of the entity in which the Disclosing Party holds a right of control: _____

OR

4. Owner of the property included in the PD Application:

Applicant: Northwestern Memorial Healthcare

B. Business address of the Disclosing Party: 10 S. LASALLE ST., SUITE 2750
CHICAGO, IL 60603

C. Telephone: 312.223.4121 Fax: 312.223.4139 Email: RACHEL.HUITSING@CTT.COM

D. Name of contact person: RACHEL HUITSING, TRUST OFFICER

E. Federal Employer Identification No. (if you have one): _____

F. Brief description of the Matter to which this EDS pertains. (Include project number and location of property, if applicable):

Planned Development application for 633 N. St. Clair Street

G. Which City agency or department is requesting this EDS? Planning and Development

If the Matter is a contract being handled by the City's Department of Procurement Services, please complete the following:

Specification # _____ and Contract # _____

SECTION II -- DISCLOSURE OF OWNERSHIP INTERESTS

A. NATURE OF THE DISCLOSING PARTY

1. Indicate the nature of the Disclosing Party:

- | | |
|---|--|
| <input type="checkbox"/> Person | <input type="checkbox"/> Limited liability company |
| <input type="checkbox"/> Publicly registered business corporation | <input type="checkbox"/> Limited liability partnership |
| <input type="checkbox"/> Privately held business corporation | <input type="checkbox"/> Joint venture |
| <input type="checkbox"/> Sole proprietorship | <input type="checkbox"/> Not-for-profit corporation |
| <input type="checkbox"/> General partnership | (Is the not-for-profit corporation also a 501(c)(3))? |
| <input type="checkbox"/> Limited partnership | <input type="checkbox"/> Yes <input type="checkbox"/> No |
| <input checked="" type="checkbox"/> Trust | <input type="checkbox"/> Other (please specify) |
-

2. For legal entities, the state (or foreign country) of incorporation or organization, if applicable:

Illinois

3. For legal entities not organized in the State of Illinois: Has the organization registered to do business in the State of Illinois as a foreign entity?

- Yes No Organized in Illinois

B. IF THE DISCLOSING PARTY IS A LEGAL ENTITY:

1. List below the full names and titles, if applicable, of: (i) all executive officers and all directors of the entity; (ii) **for not-for-profit corporations**, all members, if any, which are legal entities (if there are no such members, write "no members which are legal entities"); (iii) **for trusts, estates or other similar entities**, the trustee, executor, administrator, or similarly situated party; (iv) **for general or limited partnerships, limited liability companies, limited liability partnerships or joint ventures**, each general partner, managing member, manager or any other person or legal entity that directly or indirectly controls the day-to-day management of the Applicant.

NOTE: Each legal entity listed below must submit an EDS on its own behalf.

Name	Title
Chicago Title Land Trust Company, as Trustee	

2. Please provide the following information concerning each person or legal entity having a direct or indirect, current or prospective (i.e. within 6 months after City action) beneficial interest (including ownership) in excess of 7.5% of the Applicant. Examples of such an interest include shares in a corporation, partnership interest in a partnership or joint venture, interest of a member or manager in a

limited liability company, or interest of a beneficiary of a trust, estate or other similar entity. If none, state "None."

NOTE: Each legal entity listed below may be required to submit an EDS on its own behalf.

Name	Business Address	Percentage Interest in the Applicant
American College of Surgeons,	633 N Clair St., Chicago, IL 60611	100% beneficial interest

SECTION III – INCOME OR COMPENSATION TO, OR OWNERSHIP BY, CITY ELECTED OFFICIALS

Has the Disclosing Party provided any income or compensation to any City elected official during the 12-month period preceding the date of this EDS? Yes No

Does the Disclosing Party reasonably expect to provide any income or compensation to any City elected official during the 12-month period following the date of this EDS? Yes No

If "yes" to either of the above, please identify below the name(s) of such City elected official(s) and describe such income or compensation:

Does any City elected official or, to the best of the Disclosing Party's knowledge after reasonable inquiry, any City elected official's spouse or domestic partner, have a financial interest (as defined in Chapter 2-156 of the Municipal Code of Chicago ("MCC")) in the Disclosing Party?

Yes No

If "yes," please identify below the name(s) of such City elected official(s) and/or spouse(s)/domestic partner(s) and describe the financial interest(s).

SECTION IV – DISCLOSURE OF SUBCONTRACTORS AND OTHER RETAINED PARTIES

The Disclosing Party must disclose the name and business address of each subcontractor, attorney, lobbyist (as defined in MCC Chapter 2-156), accountant, consultant and any other person or entity whom the Disclosing Party has retained or expects to retain in connection with the Matter, as well as the nature of the relationship, and the total amount of the fees paid or estimated to be paid. The Disclosing Party is not required to disclose employees who are paid solely through the Disclosing Party's regular payroll. If the Disclosing Party is uncertain whether a disclosure is required under this Section, the Disclosing Party must either ask the City whether disclosure is required or make the disclosure.

Name (indicate whether retained or anticipated to be retained)	Business Address	Relationship to Disclosing Party (subcontractor, attorney, lobbyist, etc.)	Fees (<u>indicate whether paid or estimated.</u>) NOTE: "hourly rate" or "t.b.d." is not an acceptable response.
--	------------------	--	---

None

(Add sheets if necessary)

Check here if the Disclosing Party has not retained, nor expects to retain, any such persons or entities.

SECTION V -- CERTIFICATIONS

A. COURT-ORDERED CHILD SUPPORT COMPLIANCE

Under MCC Section 2-92-415, substantial owners of business entities that contract with the City must remain in compliance with their child support obligations throughout the contract's term.

Has any person who directly or indirectly owns 10% or more of the Disclosing Party been declared in arrearage on any child support obligations by any Illinois court of competent jurisdiction?

Yes No No person directly or indirectly owns 10% or more of the Disclosing Party.

If "Yes," has the person entered into a court-approved agreement for payment of all support owed and is the person in compliance with that agreement?

Yes No

B. FURTHER CERTIFICATIONS

1. [This paragraph 1 applies only if the Matter is a contract being handled by the City's Department of Procurement Services.] In the 5-year period preceding the date of this EDS, neither the Disclosing Party nor any Affiliated Entity [see definition in (5) below] has engaged, in connection with the performance of any public contract, the services of an integrity monitor, independent private sector inspector general, or integrity compliance consultant (i.e., an individual or entity with legal, auditing, investigative, or other similar skills, designated by a public agency to help the agency monitor the activity of specified agency vendors as well as help the vendors reform their business practices so they can be considered for agency contracts in the future, or continue with a contract in progress).

2. The Disclosing Party and its Affiliated Entities are not delinquent in the payment of any fine, fee, tax or other source of indebtedness owed to the City of Chicago, including, but not limited to, water and sewer charges, license fees, parking tickets, property taxes and sales taxes, nor is the Disclosing Party delinquent in the payment of any tax administered by the Illinois Department of Revenue.

3. The Disclosing Party and, if the Disclosing Party is a legal entity, all of those persons or entities identified in Section II(B)(1) of this EDS:

- a. are not presently debarred, suspended, proposed for debarment, declared ineligible or voluntarily excluded from any transactions by any federal, state or local unit of government;
- b. have not, during the 5 years before the date of this EDS, been convicted of a criminal offense, adjudged guilty, or had a civil judgment rendered against them in connection with: obtaining, attempting to obtain, or performing a public (federal, state or local) transaction or contract under a public transaction; a violation of federal or state antitrust statutes; fraud; embezzlement; theft; forgery; bribery; falsification or destruction of records; making false statements; or receiving stolen property;
- c. are not presently indicted for, or criminally or civilly charged by, a governmental entity (federal, state or local) with committing any of the offenses set forth in subparagraph (b) above;
- d. have not, during the 5 years before the date of this EDS, had one or more public transactions (federal, state or local) terminated for cause or default; and
- e. have not, during the 5 years before the date of this EDS, been convicted, adjudged guilty, or found liable in a civil proceeding, or in any criminal or civil action, including actions concerning environmental violations, instituted by the City or by the federal government, any state, or any other unit of local government.

4. The Disclosing Party understands and shall comply with the applicable requirements of MCC Chapters 2-56 (Inspector General) and 2-156 (Governmental Ethics).

5. Certifications (5), (6) and (7) concern:

- the Disclosing Party;
- any "Contractor" (meaning any contractor or subcontractor used by the Disclosing Party in connection with the Matter, including but not limited to all persons or legal entities disclosed under Section IV, "Disclosure of Subcontractors and Other Retained Parties");
- any "Affiliated Entity" (meaning a person or entity that, directly or indirectly: controls the Disclosing Party, is controlled by the Disclosing Party, or is, with the Disclosing Party, under common control of another person or entity). Indicia of control include, without limitation: interlocking management or ownership; identity of interests among family members, shared facilities and equipment; common use of employees; or organization of a business entity following the ineligibility of a business entity to do business with federal or state or local government, including the City, using substantially the same management, ownership, or principals as the ineligible entity. With respect to Contractors, the term Affiliated Entity means a person or entity that directly or indirectly controls the Contractor, is controlled by it, or, with the Contractor, is under common control of another person or entity;
- any responsible official of the Disclosing Party, any Contractor or any Affiliated Entity or any other official, agent or employee of the Disclosing Party, any Contractor or any Affiliated Entity, acting pursuant to the direction or authorization of a responsible official of the Disclosing Party, any Contractor or any Affiliated Entity (collectively "Agents").

Neither the Disclosing Party, nor any Contractor, nor any Affiliated Entity of either the Disclosing Party or any Contractor, nor any Agents have, during the 5 years before the date of this EDS, or, with respect to a Contractor, an Affiliated Entity, or an Affiliated Entity of a Contractor during the 5 years before the date of such Contractor's or Affiliated Entity's contract or engagement in connection with the Matter:

- a. bribed or attempted to bribe, or been convicted or adjudged guilty of bribery or attempting to bribe, a public officer or employee of the City, the State of Illinois, or any agency of the federal government or of any state or local government in the United States of America, in that officer's or employee's official capacity;
 - b. agreed or colluded with other bidders or prospective bidders, or been a party to any such agreement, or been convicted or adjudged guilty of agreement or collusion among bidders or prospective bidders, in restraint of freedom of competition by agreement to bid a fixed price or otherwise; or
 - c. made an admission of such conduct described in subparagraph (a) or (b) above that is a matter of record, but have not been prosecuted for such conduct; or
 - d. violated the provisions referenced in MCC Subsection 2-92-320(a)(4)(Contracts Requiring a Base Wage); (a)(5)(Debarment Regulations); or (a)(6)(Minimum Wage Ordinance).
6. Neither the Disclosing Party, nor any Affiliated Entity or Contractor, or any of their employees, officials, agents or partners, is barred from contracting with any unit of state or local government as a result of engaging in or being convicted of (1) bid-rigging in violation of 720 ILCS 5/33E-3; (2) bid-rotating in violation of 720 ILCS 5/33E-4; or (3) any similar offense of any state or of the United States of America that contains the same elements as the offense of bid-rigging or bid-rotating.
7. Neither the Disclosing Party nor any Affiliated Entity is listed on a Sanctions List maintained by the United States Department of Commerce, State, or Treasury, or any successor federal agency.
8. [FOR APPLICANT ONLY] (i) Neither the Applicant nor any "controlling person" [see MCC Chapter 1-23, Article I for applicability and defined terms] of the Applicant is currently indicted or charged with, or has admitted guilt of, or has ever been convicted of, or placed under supervision for, any criminal offense involving actual, attempted, or conspiracy to commit bribery, theft, fraud, forgery, perjury, dishonesty or deceit against an officer or employee of the City or any "sister agency"; and (ii) the Applicant understands and acknowledges that compliance with Article I is a continuing requirement for doing business with the City. NOTE: If MCC Chapter 1-23, Article I applies to the Applicant, that Article's permanent compliance timeframe supersedes 5-year compliance timeframes in this Section V.
9. [FOR APPLICANT ONLY] The Applicant and its Affiliated Entities will not use, nor permit their subcontractors to use, any facility listed as having an active exclusion by the U.S. EPA on the federal System for Award Management ("SAM").
10. [FOR APPLICANT ONLY] The Applicant will obtain from any contractors/subcontractors hired or to be hired in connection with the Matter certifications equal in form and substance to those in Certifications (2) and (9) above and will not, without the prior written consent of the City, use any such

contractor/subcontractor that does not provide such certifications or that the Applicant has reason to believe has not provided or cannot provide truthful certifications.

11. If the Disclosing Party is unable to certify to any of the above statements in this Part B (Further Certifications), the Disclosing Party must explain below:

If the letters "NA," the word "None," or no response appears on the lines above, it will be conclusively presumed that the Disclosing Party certified to the above statements.

12. To the best of the Disclosing Party's knowledge after reasonable inquiry, the following is a complete list of all current employees of the Disclosing Party who were, at any time during the 12-month period preceding the date of this EDS, an employee, or elected or appointed official, of the City of Chicago (if none, indicate with "N/A" or "none").

None

13. To the best of the Disclosing Party's knowledge after reasonable inquiry, the following is a complete list of all gifts that the Disclosing Party has given or caused to be given, at any time during the 12-month period preceding the execution date of this EDS, to an employee, or elected or appointed official, of the City of Chicago. For purposes of this statement, a "gift" does not include: (i) anything made generally available to City employees or to the general public, or (ii) food or drink provided in the course of official City business and having a retail value of less than \$25 per recipient, or (iii) a political contribution otherwise duly reported as required by law (if none, indicate with "N/A" or "none"). As to any gift listed below, please also list the name of the City recipient.

None

C. CERTIFICATION OF STATUS AS FINANCIAL INSTITUTION

1. The Disclosing Party certifies that the Disclosing Party (check one)

is is not

a "financial institution" as defined in MCC Section 2-32-455(b).

2. If the Disclosing Party IS a financial institution, then the Disclosing Party pledges:

"We are not and will not become a predatory lender as defined in MCC Chapter 2-32. We further pledge that none of our affiliates is, and none of them will become, a predatory lender as defined in MCC Chapter 2-32. We understand that becoming a predatory lender or becoming an affiliate of a predatory lender may result in the loss of the privilege of doing business with the City."

If the Disclosing Party is unable to make this pledge because it or any of its affiliates (as defined in MCC Section 2-32-455(b)) is a predatory lender within the meaning of MCC Chapter 2-32, explain here (attach additional pages if necessary):

None

If the letters "NA," the word "None," or no response appears on the lines above, it will be conclusively presumed that the Disclosing Party certified to the above statements.

D. CERTIFICATION REGARDING FINANCIAL INTEREST IN CITY BUSINESS

Any words or terms defined in MCC Chapter 2-156 have the same meanings if used in this Part D.

1. In accordance with MCC Section 2-156-110: To the best of the Disclosing Party's knowledge after reasonable inquiry, does any official or employee of the City have a financial interest in his or her own name or in the name of any other person or entity in the Matter?

Yes

No

NOTE: If you checked "Yes" to Item D(1), proceed to Items D(2) and D(3). If you checked "No" to Item D(1), skip Items D(2) and D(3) and proceed to Part E.

2. Unless sold pursuant to a process of competitive bidding, or otherwise permitted, no City elected official or employee shall have a financial interest in his or her own name or in the name of any other person or entity in the purchase of any property that (i) belongs to the City, or (ii) is sold for taxes or assessments, or (iii) is sold by virtue of legal process at the suit of the City (collectively, "City Property Sale"). Compensation for property taken pursuant to the City's eminent domain power does not constitute a financial interest within the meaning of this Part D.

Does the Matter involve a City Property Sale?

Yes

No

3. If you checked "Yes" to Item D(1), provide the names and business addresses of the City officials or employees having such financial interest and identify the nature of the financial interest:

Name	Business Address	Nature of Financial Interest
<hr/>		
<hr/>		
<hr/>		

4. The Disclosing Party further certifies that no prohibited financial interest in the Matter will be acquired by any City official or employee.

E. CERTIFICATION REGARDING SLAVERY ERA BUSINESS

Please check either (1) or (2) below. If the Disclosing Party checks (2), the Disclosing Party must disclose below or in an attachment to this EDS all information required by (2). Failure to comply with these disclosure requirements may make any contract entered into with the City in connection with the Matter voidable by the City.

1. The Disclosing Party verifies that the Disclosing Party has searched any and all records of the Disclosing Party and any and all predecessor entities regarding records of investments or profits from slavery or slaveholder insurance policies during the slavery era (including insurance policies issued to slaveholders that provided coverage for damage to or injury or death of their slaves), and the Disclosing Party has found no such records.

2. The Disclosing Party verifies that, as a result of conducting the search in step (1) above, the Disclosing Party has found records of investments or profits from slavery or slaveholder insurance policies. The Disclosing Party verifies that the following constitutes full disclosure of all such records, including the names of any and all slaves or slaveholders described in those records:

SECTION VI -- CERTIFICATIONS FOR FEDERALLY FUNDED MATTERS

NOTE: If the Matter is federally funded, complete this Section VI. If the Matter is not federally funded, proceed to Section VII. For purposes of this Section VI, tax credits allocated by the City and proceeds of debt obligations of the City are not federal funding.

A. CERTIFICATION REGARDING LOBBYING

1. List below the names of all persons or entities registered under the federal Lobbying Disclosure Act of 1995, as amended, who have made lobbying contacts on behalf of the Disclosing Party with respect to the Matter: (Add sheets if necessary):

(If no explanation appears or begins on the lines above, or if the letters "NA" or if the word "None" appear, it will be conclusively presumed that the Disclosing Party means that NO persons or entities registered under the Lobbying Disclosure Act of 1995, as amended, have made lobbying contacts on behalf of the Disclosing Party with respect to the Matter.)

2. The Disclosing Party has not spent and will not expend any federally appropriated funds to pay any person or entity listed in paragraph A(1) above for his or her lobbying activities or to pay any person or entity to influence or attempt to influence an officer or employee of any agency, as defined by applicable federal law, a member of Congress, an officer or employee of Congress, or an employee

of a member of Congress, in connection with the award of any federally funded contract, making any federally funded grant or loan, entering into any cooperative agreement, or to extend, continue, renew, amend, or modify any federally funded contract, grant, loan, or cooperative agreement.

3. The Disclosing Party will submit an updated certification at the end of each calendar quarter in which there occurs any event that materially affects the accuracy of the statements and information set forth in paragraphs A(1) and A(2) above.

4. The Disclosing Party certifies that either: (i) it is not an organization described in section 501(c)(4) of the Internal Revenue Code of 1986; or (ii) it is an organization described in section 501(c)(4) of the Internal Revenue Code of 1986 but has not engaged and will not engage in "Lobbying Activities," as that term is defined in the Lobbying Disclosure Act of 1995, as amended.

5. If the Disclosing Party is the Applicant, the Disclosing Party must obtain certifications equal in form and substance to paragraphs A(1) through A(4) above from all subcontractors before it awards any subcontract and the Disclosing Party must maintain all such subcontractors' certifications for the duration of the Matter and must make such certifications promptly available to the City upon request.

B. CERTIFICATION REGARDING EQUAL EMPLOYMENT OPPORTUNITY

If the Matter is federally funded, federal regulations require the Applicant and all proposed subcontractors to submit the following information with their bids or in writing at the outset of negotiations.

Is the Disclosing Party the Applicant?

Yes No

If "Yes," answer the three questions below:

1. Have you developed and do you have on file affirmative action programs pursuant to applicable federal regulations? (See 41 CFR Part 60-2.)

Yes No

2. Have you filed with the Joint Reporting Committee, the Director of the Office of Federal Contract Compliance Programs, or the Equal Employment Opportunity Commission all reports due under the applicable filing requirements?

Yes No Reports not required

3. Have you participated in any previous contracts or subcontracts subject to the equal opportunity clause?

Yes No

If you checked "No" to question (1) or (2) above, please provide an explanation:

SECTION VII -- FURTHER ACKNOWLEDGMENTS AND CERTIFICATION

The Disclosing Party understands and agrees that:

A. The certifications, disclosures, and acknowledgments contained in this EDS will become part of any contract or other agreement between the Applicant and the City in connection with the Matter, whether procurement, City assistance, or other City action, and are material inducements to the City's execution of any contract or taking other action with respect to the Matter. The Disclosing Party understands that it must comply with all statutes, ordinances, and regulations on which this EDS is based.

B. The City's Governmental Ethics Ordinance, MCC Chapter 2-156, imposes certain duties and obligations on persons or entities seeking City contracts, work, business, or transactions. The full text of this ordinance and a training program is available on line at www.cityofchicago.org/Ethics, and may also be obtained from the City's Board of Ethics, 740 N. Sedgwick St., Suite 500, Chicago, IL 60610, (312) 744-9660. The Disclosing Party must comply fully with this ordinance.

C. If the City determines that any information provided in this EDS is false, incomplete or inaccurate, any contract or other agreement in connection with which it is submitted may be rescinded or be void or voidable, and the City may pursue any remedies under the contract or agreement (if not rescinded or void), at law, or in equity, including terminating the Disclosing Party's participation in the Matter and/or declining to allow the Disclosing Party to participate in other City transactions. Remedies at law for a false statement of material fact may include incarceration and an award to the City of treble damages.

D. It is the City's policy to make this document available to the public on its Internet site and/or upon request. Some or all of the information provided in, and appended to, this EDS may be made publicly available on the Internet, in response to a Freedom of Information Act request, or otherwise. By completing and signing this EDS, the Disclosing Party waives and releases any possible rights or claims which it may have against the City in connection with the public release of information contained in this EDS and also authorizes the City to verify the accuracy of any information submitted in this EDS.

E. The information provided in this EDS must be kept current. In the event of changes, the Disclosing Party must supplement this EDS up to the time the City takes action on the Matter. If the Matter is a contract being handled by the City's Department of Procurement Services, the Disclosing Party must update this EDS as the contract requires. **NOTE:** With respect to Matters subject to MCC Chapter 1-23, Article I (imposing **PERMANENT INELIGIBILITY** for certain specified offenses), the information provided herein regarding eligibility must be kept current for a longer period, as required by MCC Chapter 1-23 and Section 2-154-020.

CERTIFICATION

Under penalty of perjury, the person signing below: (1) warrants that he/she is authorized to execute this EDS, and all applicable Appendices, on behalf of the Disclosing Party, and (2) warrants that all certifications and statements contained in this EDS, and all applicable Appendices, are true, accurate and complete as of the date furnished to the City.

Chicago Title Land Trust Company, T/LUT/A dtd February 1, 1996 and known as Trust No. 121309-2

(Print or type exact legal name of Disclosing Party)

By: *Rachel Huitsing*
(Sign here)

Rachel Huitsing
(Print or type name of person signing)

Trust Officer, Assistant Vice President
(Print or type title of person signing)



The information contained in this certification has been furnished to the land trustee for the beneficiaries of trust no. 121309-2, and the certification is made solely in reliance thereon and no responsibility is assumed by the trustee in its individual capacity, for the truth or accuracy of the facts therein stated.

Signed and sworn to before me on (date) 02/24/2022,

at Cook County, Illinois (state).

Natalie Foster
Notary Public



Commission expires: 07/01/2025

This instrument is executed by the undersigned Land Trustee, not personally but solely as Trustee in the exercise of the power and authority conferred upon and vested in it as such Trustee. It is expressly understood and agreed that all the warranties, indemnities, representations, covenants, undertakings and agreements herein made on the part of the Trustee are undertaken by it solely in its capacity as Trustee and not personally. No personal liability or personal responsibility is assumed by or shall at any time be asserted or enforceable against the Trustee on account of any warranty, indemnity, representation, covenant, undertaking or agreement of the Trustee in this instrument.

**CITY OF CHICAGO
ECONOMIC DISCLOSURE STATEMENT AND AFFIDAVIT
APPENDIX A**

**FAMILIAL RELATIONSHIPS WITH ELECTED CITY OFFICIALS
AND DEPARTMENT HEADS**

This Appendix is to be completed only by (a) the Applicant, and (b) any legal entity which has a direct ownership interest in the Applicant exceeding 7.5%. It is not to be completed by any legal entity which has only an indirect ownership interest in the Applicant.

Under MCC Section 2-154-015, the Disclosing Party must disclose whether such Disclosing Party or any "Applicable Party" or any Spouse or Domestic Partner thereof currently has a "familial relationship" with any elected city official or department head. A "familial relationship" exists if, as of the date this EDS is signed, the Disclosing Party or any "Applicable Party" or any Spouse or Domestic Partner thereof is related to the mayor, any alderman, the city clerk, the city treasurer or any city department head as spouse or domestic partner or as any of the following, whether by blood or adoption: parent, child, brother or sister, aunt or uncle, niece or nephew, grandparent, grandchild, father-in-law, mother-in-law, son-in-law, daughter-in-law, stepfather or stepmother, stepson or stepdaughter, stepbrother or stepsister or half-brother or half-sister.

"Applicable Party" means (1) all executive officers of the Disclosing Party listed in Section II.B.1.a., if the Disclosing Party is a corporation; all partners of the Disclosing Party, if the Disclosing Party is a general partnership; all general partners and limited partners of the Disclosing Party, if the Disclosing Party is a limited partnership; all managers, managing members and members of the Disclosing Party, if the Disclosing Party is a limited liability company; (2) all principal officers of the Disclosing Party; and (3) any person having more than a 7.5% ownership interest in the Disclosing Party. "Principal officers" means the president, chief operating officer, executive director, chief financial officer, treasurer or secretary of a legal entity or any person exercising similar authority.

Does the Disclosing Party or any "Applicable Party" or any Spouse or Domestic Partner thereof currently have a "familial relationship" with an elected city official or department head?

Yes

No

If yes, please identify below (1) the name and title of such person, (2) the name of the legal entity to which such person is connected; (3) the name and title of the elected city official or department head to whom such person has a familial relationship, and (4) the precise nature of such familial relationship.

**CITY OF CHICAGO
ECONOMIC DISCLOSURE STATEMENT AND AFFIDAVIT
APPENDIX B**

BUILDING CODE SCOFFLAW/PROBLEM LANDLORD CERTIFICATION

This Appendix is to be completed only by (a) the Applicant, and (b) any legal entity which has a direct ownership interest in the Applicant exceeding 7.5% (an "Owner"). It is not to be completed by any legal entity which has only an indirect ownership interest in the Applicant.

1. Pursuant to MCC Section 2-154-010, is the Applicant or any Owner identified as a building code scofflaw or problem landlord pursuant to MCC Section 2-92-416?

Yes No

2. If the Applicant is a legal entity publicly traded on any exchange, is any officer or director of the Applicant identified as a building code scofflaw or problem landlord pursuant to MCC Section 2-92-416?

Yes No The Applicant is not publicly traded on any exchange.

3. If yes to (1) or (2) above, please identify below the name of each person or legal entity identified as a building code scofflaw or problem landlord and the address of each building or buildings to which the pertinent code violations apply.

**CITY OF CHICAGO
ECONOMIC DISCLOSURE STATEMENT AND AFFIDAVIT
APPENDIX C**

PROHIBITION ON WAGE & SALARY HISTORY SCREENING - CERTIFICATION

This Appendix is to be completed only by an Applicant that is completing this EDS as a “contractor” as defined in MCC Section 2-92-385. That section, which should be consulted (www.amlegal.com), generally covers a party to any agreement pursuant to which they: (i) receive City of Chicago funds in consideration for services, work or goods provided (including for legal or other professional services), or (ii) pay the City money for a license, grant or concession allowing them to conduct a business on City premises.

On behalf of an Applicant that is a contractor pursuant to MCC Section 2-92-385, I hereby certify that the Applicant is in compliance with MCC Section 2-92-385(b)(1) and (2), which prohibit: (i) screening job applicants based on their wage or salary history, or (ii) seeking job applicants’ wage or salary history from current or former employers. I also certify that the Applicant has adopted a policy that includes those prohibitions.

Yes

No

N/A – I am not an Applicant that is a “contractor” as defined in MCC Section 2-92-385.

This certification shall serve as the affidavit required by MCC Section 2-92-385(c)(1).

If you checked “no” to the above, please explain.
